

Приложение 2 към Техническо предложение

„Доставка на електромерни табла НН, за индиректно измерване“

ИЗИСКВАНИ ДОКУМЕНТИ ОТ ТЕХНИЧЕСКИ

ИЗИСКВАНИЯ И СПЕЦИФИКАЦИИ

Приложение 6

u





ИНСТРУКЦИИ ЗА ТРАНСПОРТ, СКЛАДИРАНЕ, МОНТИРАНЕ, ПОДДЪРЖАНЕ И ЕКСПЛОАТАЦИЯ

Транспортиране и складиране:

Комплектите измервателен клемен блок с клеми за медни проводници от проходен тип и 1P, 3P или 3P+N стопяеми цилиндрични предпазител-прекъсвач-разединители трябва да се транспортират в заводската си опаковка, добре застопорени, за избягване на наранявания на изделието, механични повреди и в следствие отклонения от характеристиките и създаване на нежелани условия за нарушаване безопасността на електрическата верига и работа.

Клемните блокове, както и цилиндричните стопяеми предпазител-прекъсвач-разединители, както и предпазителите трябва да се съхраняват в сухи помещения при нормална температура.

Инсталация и работа

Инсталирането и монтажа става единствено и само според инструкциите на производителя, съгласно техническите каталози и документацията придружаваща доставката!

За безопасността на лицето и електрическо оборудване, трябва да се спазват следните инструкции, преди да пуснете в експлоатация клемните блокове:

- Моля, прочетете тази инструкция за експлоатация внимателно преди инсталиране на клемните блокове, както и инструкцията от доставчика/ производителя, която съпътства доставката.
- клемните блокове трябва да се използват при нормални условия на експлоатация.
- Проверете възможностите на клемните блокове за точното им приложение, преди инсталацията.
- Инсталацията клемните блокове в избрана позиция е възможно, без влияние върху неговата ефективност. Определено разстояние отгоре, отдолу, отстрани и отпред, както и от други елементи следва да бъде спазено за безопасна работа.
- Трябва да се внимава да не попаднат чужди проводими предмети в клемните блокове, когато го инсталирате.
- Кабелите, използвани за свързване на клемните блокове трябва да бъде гладки, ненаранени и да не са пречупени при инсталацията на клемните блокове, с цел предотвратяване на повреди на клемните блокове и отклонения от стандартни им характеристики.
- След като инсталирате клемните блокове, следва да се направят оперативни тестове преди да се пусне веригата. Тя не може да бъде пусната в експлоатация докато всички условия не са коректни и точни;

Поддръжка

- По време на работа, клемните блокове се проверяват периодично.
- Почистете всяко прекомерно натрупване на прах, за да бъде изолацията на клемните блокове в добро състояние.
- Проверка на условията за експлоатация на клемните блокове след всяко кратко прекъсване на клемните блокове, сменете нов, ако не е в състояние да бъде използван.

Ремонт

Проблеми могат да възникнат по време на инсталация, настройка или експлоатация на клемните блокове. Решаването на проблемите се извършва от квалифицирани лица или можете да се свържете с офис на дистрибутора, където инженери ще ви помогнат и ще предоставят допълнителни услуги.

ЗА ДЕТАЙЛИ ПО СПЕЦИФИКАТА НА МОНТАЖ И ДРУГИ УКАЗАНИЯ, МОЛЯ ПОЛЗВАЙТЕ УКАЗАНИЯТА НА ПРОИЗВОДИТЕЛЯ, ПОДРОБНО ОПИСАНИ В КАТАЛОЗИТЕ.

Забележка:

Въртящ момент на затягане на клемата/ винт: 1,5 / 1,5Nm;

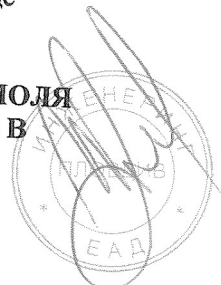

Приложение 2 към Техническо предложение

„Доставка на електромерни табла НН, за индиректно измерване“

ИЗИСКВАНИ ДОКУМЕНТИ ОТ ТЕХНИЧЕСКИ

ИЗИСКВАНИЯ И СПЕЦИФИКАЦИИ

Приложение 7

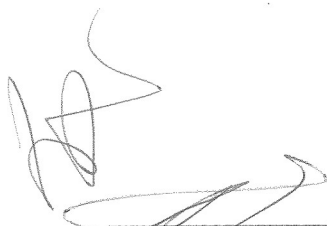

REGLETAS EPI DE ALTA SEGURIDAD

PARA VERIFICACIÓN DE CONTADORES EN PUNTOS FRONTERA

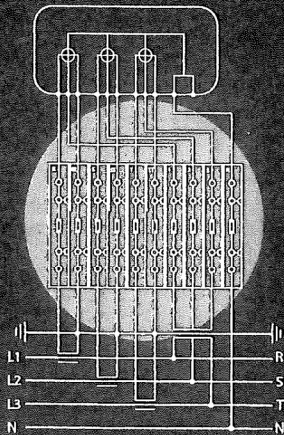
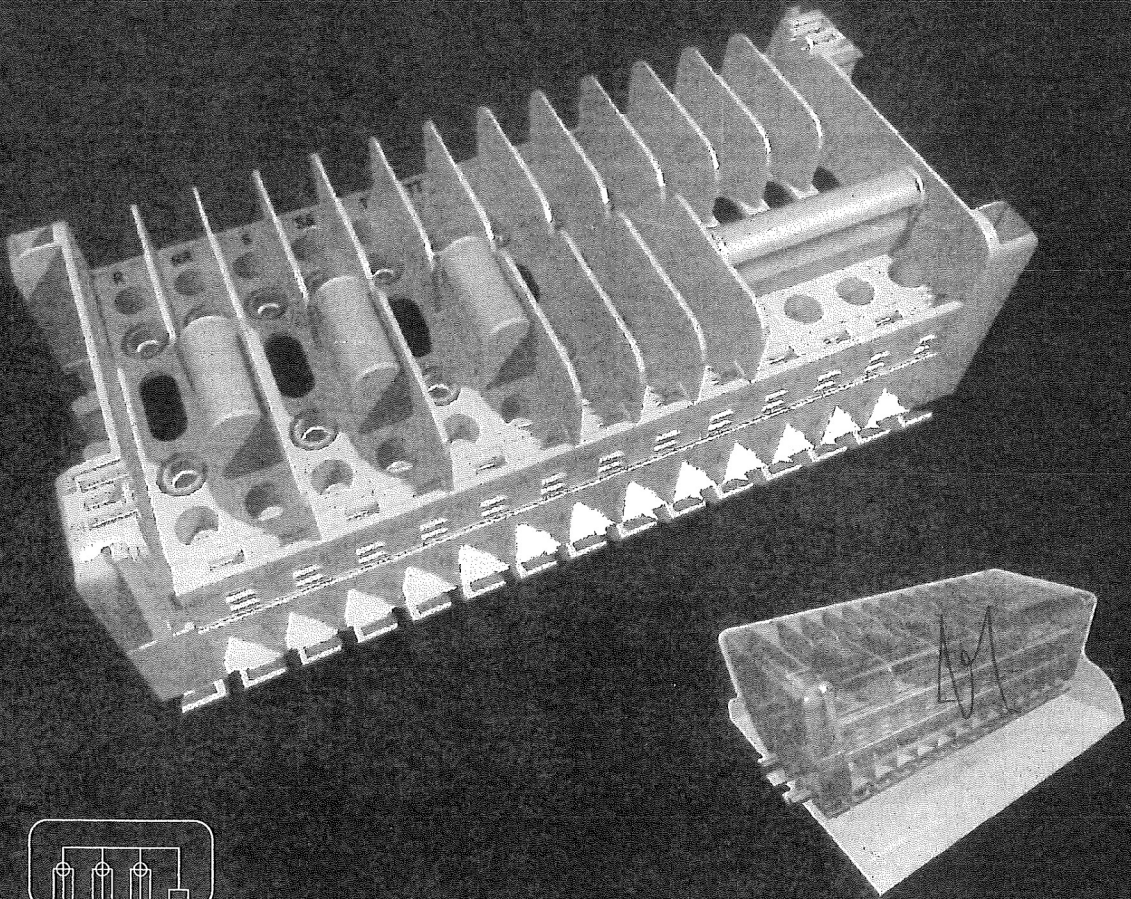

MEDIDA DE ENERGIA ELECTRICA EN AT Y BT

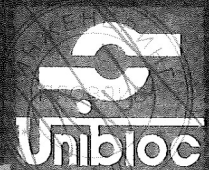

730

INTRODUCTION



The kWh-Meter Test Block Units from **Unibloc** have specially been designed in close collaboration with several Electrical Utility Companies. Thus, we have been able to get a final product which fully matches the highest needs and expectations.

Unibloc (formerly CIAMA) has been working very close to different Electrical Utility Companies for more than 40 years, by innovating and developing new applications according to the new safety and security regulations.

This catalogue is about the new EPI type kWh-Meter Test Block Units. These EPI units have carefully been designed to ensure that the testing procedures comply with the legislation related to the prevention of any electric risk.

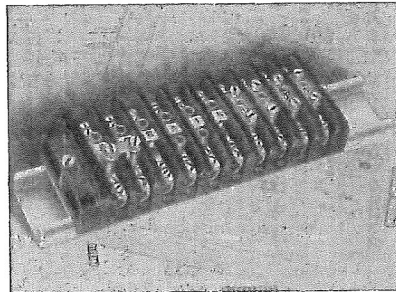

1967 Model

This is an open catalogue in which you can find the typical Test Block Units, as well as any necessary information about how to set up a kWh-Test Block Unit according to any special requirements of most of the Electrical Utility Companies.

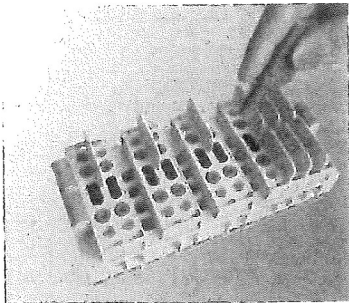

2008 New EPI model

We would like to thank to all the people involved in the development of these products, legal literature, etc. for their shares and inputs in the present catalogue.

Promotora de Mercados Eléctricos, S.A.
Unibloc

ВЯРНО С ОРИГИНАЛА



INTRODUCTION	2
INDEX	3
OVERVIEW	4
MOST FREQUENTLY USED TEST BLOCK UNITS	
with 1 element per current phase	8
with 2 elements per current phase	10
with 3 elements per current phase	14
for voltage circuits only	16
with fuse blocks on voltage circuits	17
INSTALATION	18
APLICATION EXAMPLES	20
TECHNICAL INFORMATION	24
ASSEMBLING COMPONENTS	
Terminal blocks	26
Plugs	28
Other accessories and marking	29
Protection covers	30

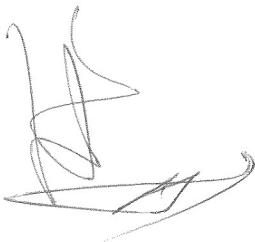

ВЯРНО С ОРИГИНАЛА



EPI kWh-meter Test Block Units

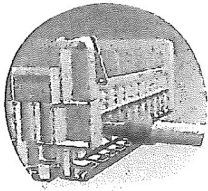

From 1,5 mm²
up to 16 mm²

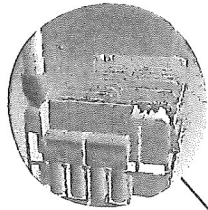

Modeller for cable
end terminals
patent ES 2279726 B1

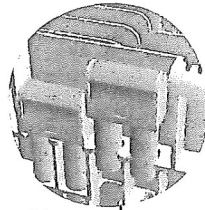

Removable
jumper plugs
2 x 2 poles
1 x 4 poles

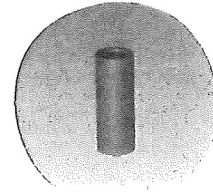

IP 20 socket
insulation
9 colours available



RB8
EN 60947-7-1
800V
16 mm²
76A

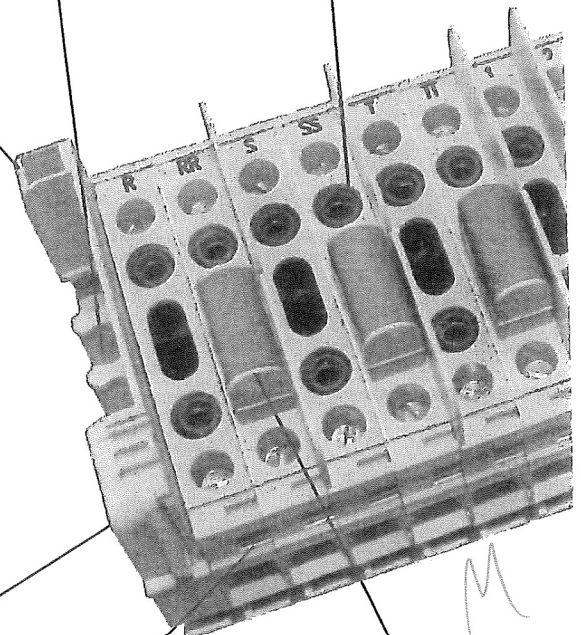
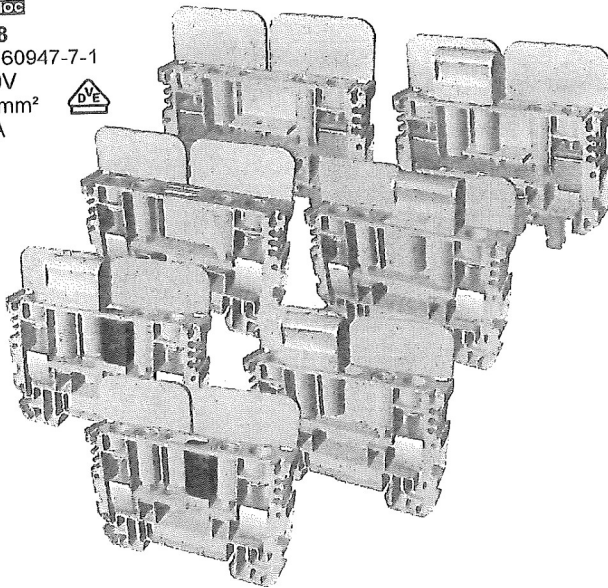

Panel self drilling
screws (included)

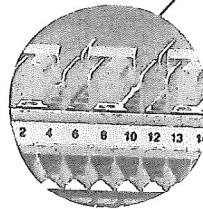
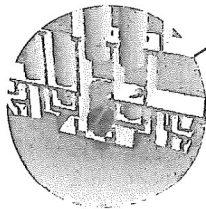

Additional
clamping units
marking

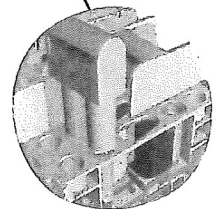

APPLICATIONS

- This Test Block unit is suitable for testing kWh-meter equipment at both Grid and Industrial + Commercial metering points.
- It is fitted between measuring equipment and transformers. It allows for opening and closing any circuit, also enabling to carry out ammeter and voltmeter measuring, to provide auxiliary energy feeding for calibration and to replace and/or connect auxiliary equipment.
- It ensures that checking jobs are carried out without cutting the energy supply and grants full safety for the operators, in conformity with European Directives and with regulations governing prevention of risks at work.
- To be fitted in all places and under all conditions, even when sealing of the kWh-meter test block is mandatory and protection against tampering required.

ВЯРНО С ОРИГИНАЛА

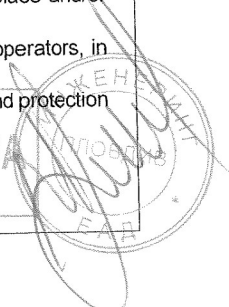

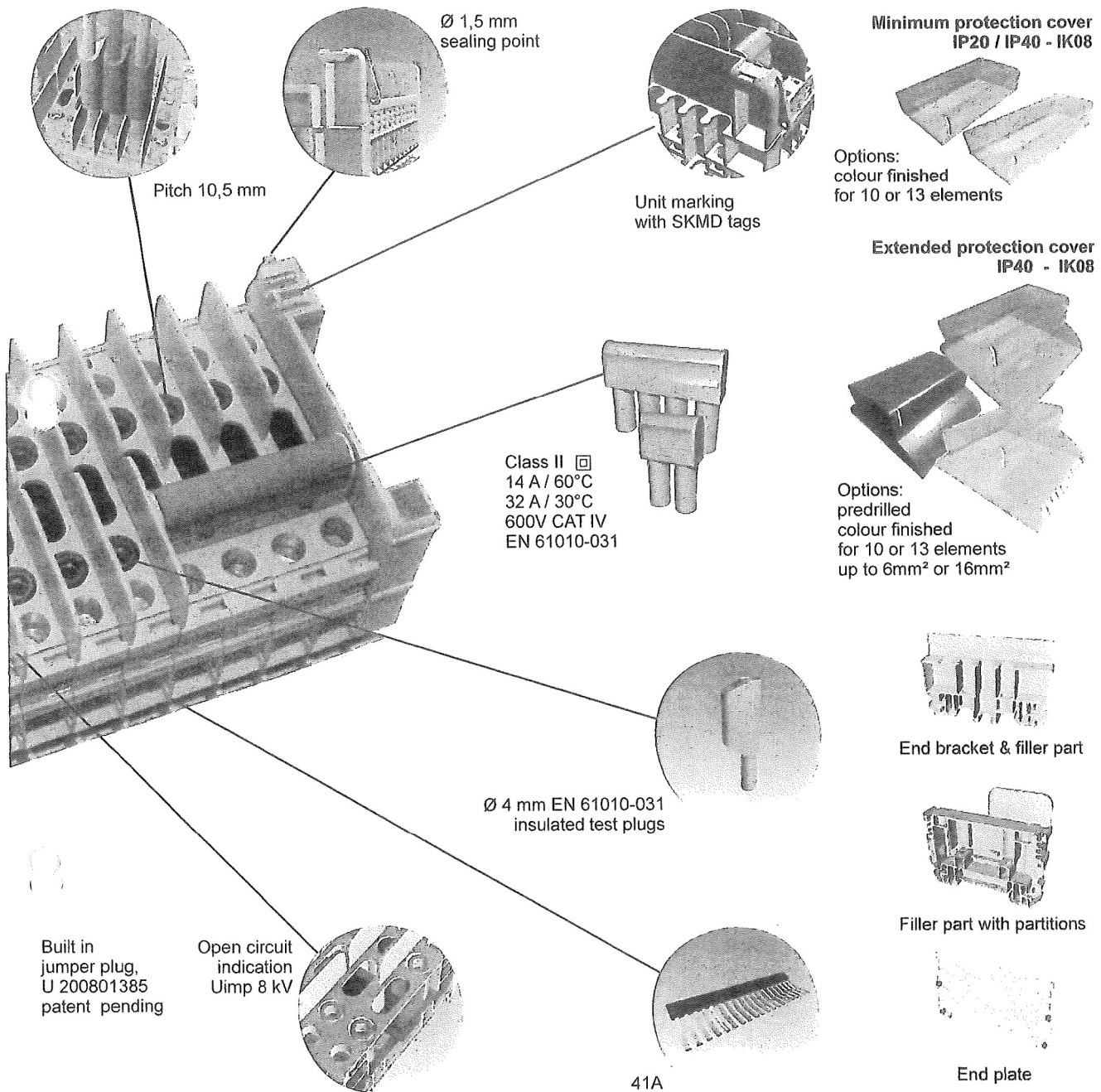

ADVANTAGES

- **SAFETY.** The Test Block unit is fully protected against finger contact. It has been designed to take standard Ø 4 mm. insulated probes or plugs which are indispensable for checking under safety. All hand held parts fitted with suitable insulation while performing checking procedures.
- **OPERATION.** Simplicity = Safety. The modular construction and the disconnect systems make it possible to set up safe, easy and intuitive operational procedures. Status is always displayed. Partition plates prevent from wrong jumpering. Marking, optionally coloured sockets if required, both make operation easier.
- **CONSTRUCTIONAL.** Conductor parts are oversized so as to reduce losses. No contact pressure exerted through insulating materials. Screw fastening is safest and most dependable in the long run, where the device is to be very often operated.
- **INSTALLATION.** Design of the enveloping cover and of the fastening system both allow for the need of a minimum space. Aesthetics in the design of the Test Block unit have been highly taken into consideration so as to match state-of-the-art equipment fitted in today's meter panels.

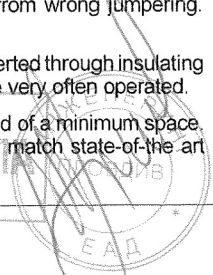

kWh-METER TESTING UNITS

DESIGN FEATURES



IP 20 Protection granted

- Access to the plug sockets, to the longitudinal sliding link and to the terminal block fastening screws, all meet the fingerproof test thereby affording an IP20 protection degree accordingly to IEC 60529 standard.

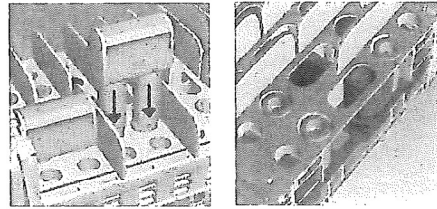

Fully protected plugs used

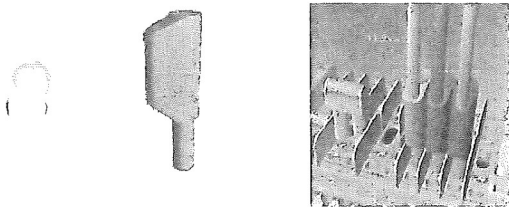

- The sockets of each element are so designed as to take protected plugs fitted with fixed sleeve, for a working insulation voltage higher than 33 V r.m.s. according to IEC 61010-031 standard.
- The 10,5 mm. pitch of the RB8 series terminal blocks also allows for simultaneous insertion of standard \varnothing 4 mm. plugs in adjacent terminal blocks.

Note: IEC 61010-031 considers that voltage level above 33 V r.m.s, 46,7 V peak or 70 V d.c. is deemed to be HAZARDOUS LIVE

Open circuit indication

- The longitudinal disconnect system is designed so the open status of the sleeve is easily viewed by a red colour indication.
- Fitted with a rugged M4 screw operated by means of one only insulated 5 mm x 1 mm. width screwdriver.
- Meets the IEC 60947-1 and IEC 60947-7-1 principle "NON CONTACT PRESURE SHALL BE TRANSMITTED THROUGH THE INSULATING MATERIALS". This principle applies to all contacts of Unibloc test block units.

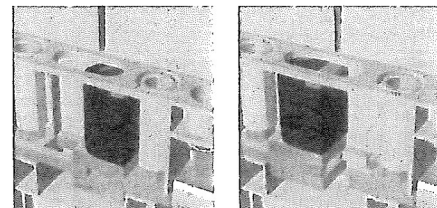

Two options for perpendicular disconnection

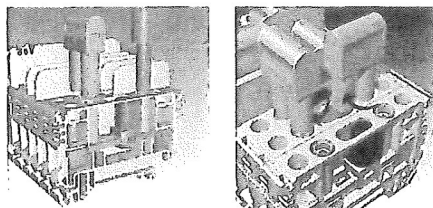

1. By means of 2-poles or 4-poles removable jumper plugs. The jumper plugs might be housed on both side end brackets.
 2. By means of 2-poles non-removable jumper plugs, which stay in their element. When not being used, the non-removable jumper plugs stay in the same place, in one of the sockets.
- Filler parts are placed for avoiding any undesired short-circuit connection.

Cover options

- Made of fire resistant transparent polycarbonate, offering an IP 40 degree of protection and an IK08 impact strength as per IEC 50102 standard in two protection levels.
 1. **Basic or minimum protection:** protects from access to functional elements against non authorized operations.
 2. **Extended protection:** protects from access to any live part with wires higher than 1 mm \varnothing from malicious purposes.
- Optional non-transparent covers are available. Additionally, extended protection covers can be drilled on one or both of top/bottom sides providing an easier connection of incoming cables atop the base plate.



kWh-METER TESTING UNITS

DESIGN FEATURES



Fastening and sealing

- The protection cover is fastened and sealed on both end brackets by means of an ergonomic clip latch system. Sealing wire to be used, \varnothing 1,5 mm. max.
- Fixing of both test block unit to panel and end brackets to Din rail is carried out by the same fastening screw. The sealed enveloping cover offers safe protection and prevents removal of the screw.

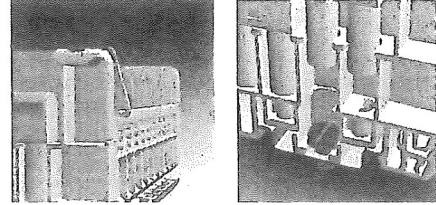

Recess for the jumper plugs

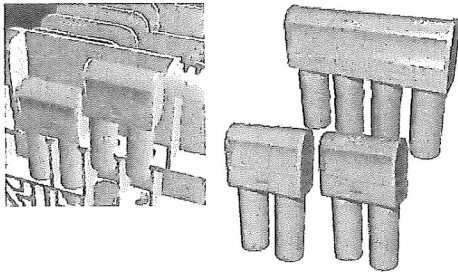

- The removable jumper plugs are housed on both side end brackets and remain always protected by the sealable enveloping cover.
- Each end bracket can house either one 4-pole or two 2-pole plugs.

Dual marking system

Unibloc test block units use two marking possibilities :

1. On the front, showing the circuit being operated to the controller.
2. On both bottom sides, showing connection points to the panel builder.

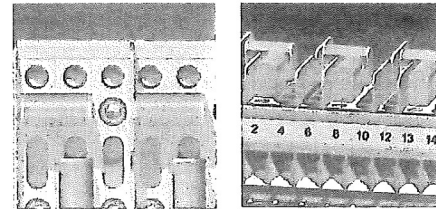

Connections up to 16 mm²

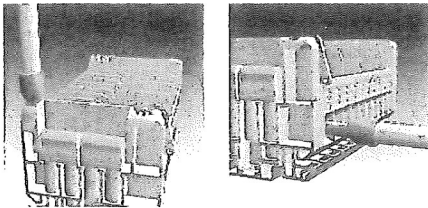

- Whenever transformers lie at some distance and the use of a larger cable section is therefore required, Unibloc test block units make the task of using 16 mm² stranded wire cable much easier by means of a modeller for cable end terminals built in at both end brackets, which enables to set on the spot such terminals with no extra tools.

Other accessories

Unibloc test block units can be delivered in different configurations.

- Insulated colour coded plug sockets can be fitted for an easier identification of circuits, as well as special colour for the terminal blocks is available.
- Jumper comb bars for neutral connections are available when cross-connection + earthing is necessary, also in combination with RBT8 earthing terminal block accordingly to IEC 60947-7-2 standard.
- Stoppers or filling elements can be used to complete free space to meet protection cover sizes.

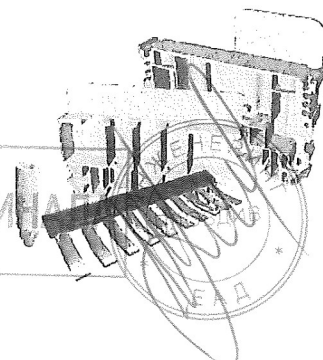

ВЯРНО С ОРИГИНАЛ

kWh-METER TESTING UNITS

with 1 current terminals per phase for 4 mm Ø insulated test plugs



4E 4I EPI



Test Block Unit only for current transformers with one current circuit element per phase. Neutral is common to the three phases.

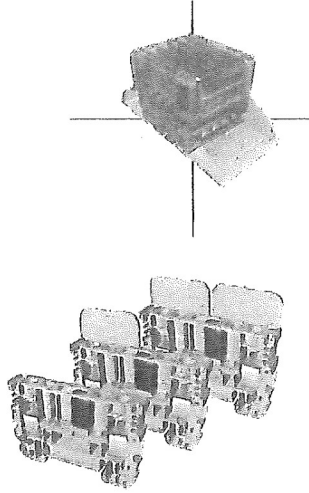
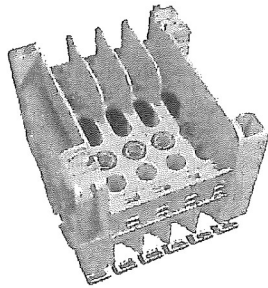

800V 16mm² 76A
EN 60947-7-1

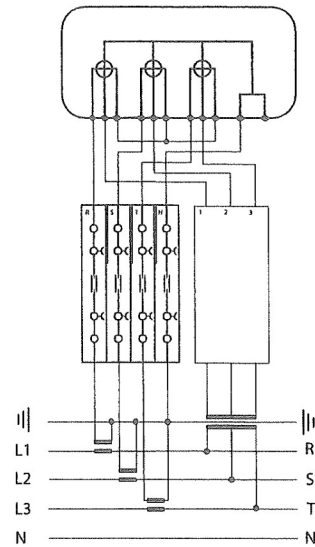

Code No.	Part No.	Applications / Options	Weight	Packing	V	mm ²	A
549385	UNB 4E 4I EPI	4e Extended protection plus filler parts	100	1-20	600	6	32
549364	UNB 4E 4I-M EPI	Minimum protection cover	80	1-20	600	16	32
549268	REG 4E 4I EPI	Set without rail and without cover	80	1-24	600	16	32

7E 4I-3T EPI



Test Block Unit for current circuits with one element per phase and voltage circuits. One common element.

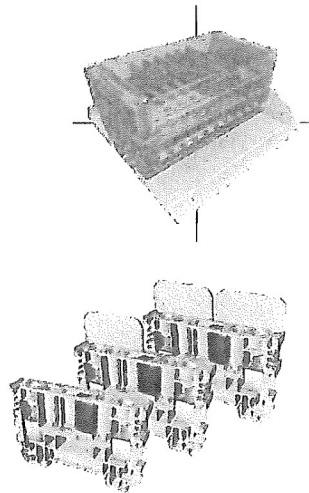
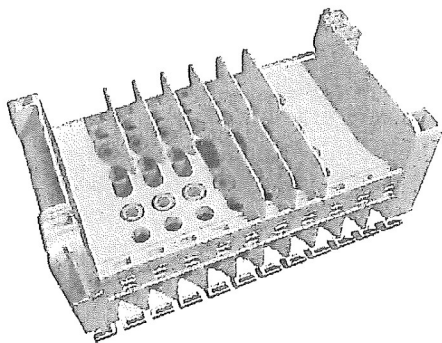

800V 16mm² 76A
EN 60947-7-1

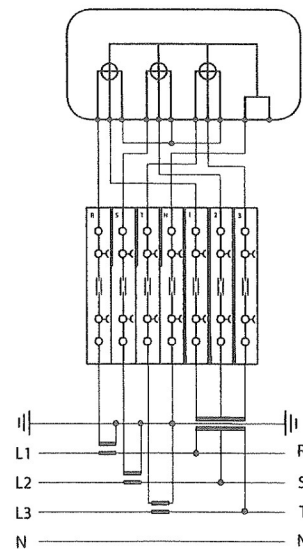

Code No.	Part No.	Applications / Options	Weight	Packing	V	mm ²	A
549333	CSE AT 7E 4I-3T EPI	10e Extended protection cover	400	1-20	600	6	32

ВЯРНО С ОРИГИНАЛА

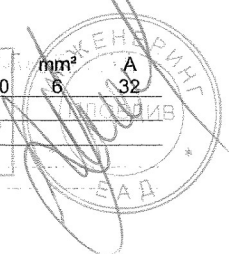

kWh-METER TESTING UNITS

with 1 current terminals per phase for 4 mm Ø insulated test plugs



UNB 8E 4I-4T-S EPI



Test Block Unit for current circuits with one element per phase and for voltage circuits. Two different neutral elements for current and voltage circuits.

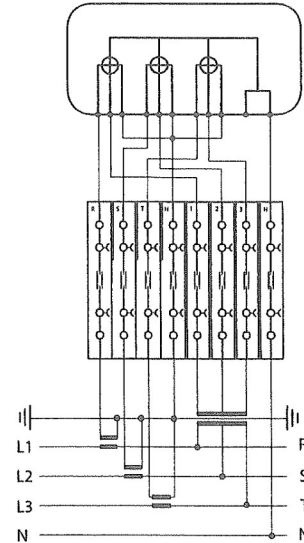
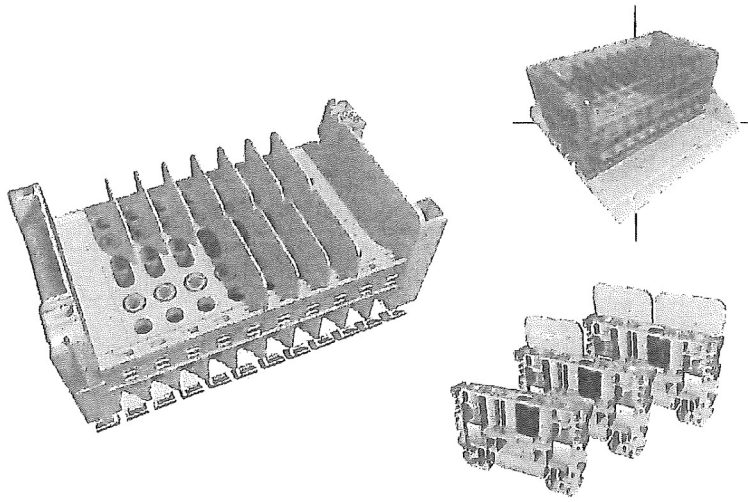

800V 16mm² 76A
EN 60947-7-1

Code No.	Part No.	Applications / Options	Weight	Packing	V	mm ²	A
549217	EEI 8E EPI	10e Extended protection cover plus filler parts	400	1-20	600	6	32
549358	UNB 8E 4I-4T-M EPI	10e Minimum protection cover	380	1-40	600	16	32

7E 4I-3T-AT EPI



Test Block Unit for HV measuring meters, two phases reading. Current circuits with two elements per phase. No neutral element. Two pole removable jumper plugs.

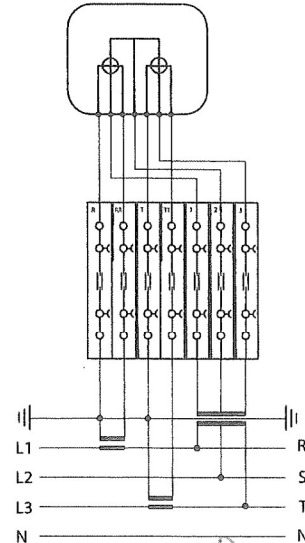
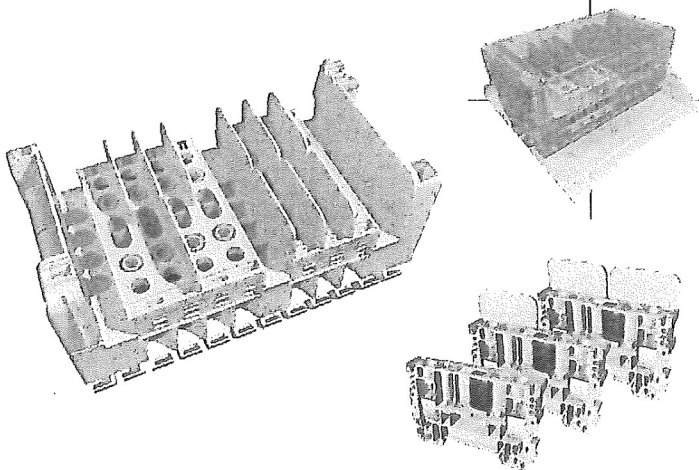

800V 16mm² 76A
EN 60947-7-1

Code No.	Part No.	Applications / Options	Weight	Packing	V	mm ²	A
549000	ID 7E 4I-3T-AT EPI	10e Extended protection cover	400	1-20	600	6	32
549334	UNB 7E 4I-3T EPI	Without cover	380	1-40	600	16	32
549376	UNB 7E 4I-3T-AT EPI	10e Extended protection cover	400	1-20	600	6	32

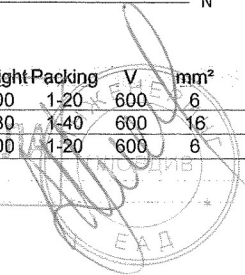

kWh-METER TESTING UNITS

with 2 current terminals per phase for 4 mm Ø insulated test plugs



6E 6I EPI



Test Block Unit only for current circuits, with two elements per phase and removable jumper plugs.

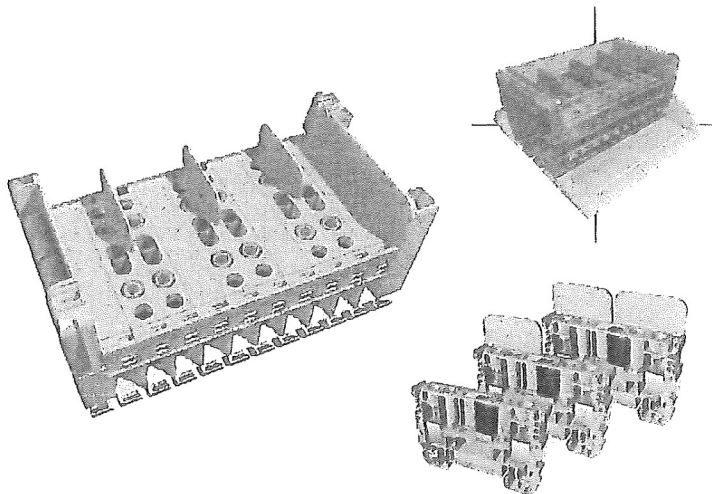

800V 16mm² 76A
EN 60947-7-1

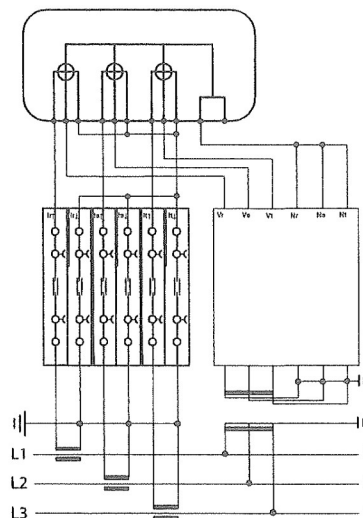

Code No.	Part No.	Applications / Options	Weight	Packing	V	mm ²	A
549236	ID 6E 6I EPI	10e extended protection cover plus filler parts.	100	1-20	600	6	32
549313	UF AT 6E 6I EPI	10e extended protection cover plus filler parts.	100	1-24	600	6	32
549359	UNB 6E 6I-M EPI	Minimum protection cover	90	1-24	600	16	32
549386	UNB 6E 6I EPI	10e extended protection cover plus filler parts.	100	1-24	600	6	32

UF 10E 6I-4T EPI



Test Block Unit for current and voltage circuits with 2 elements per phase on the current circuit, removable jumper plugs and double terminal identification

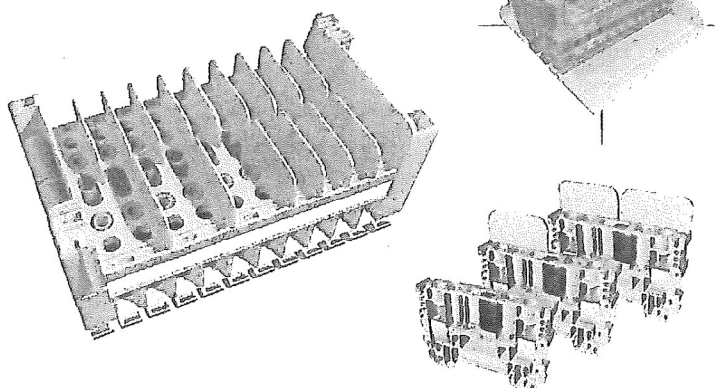

800V 16mm² 76A
EN 60947-7-1

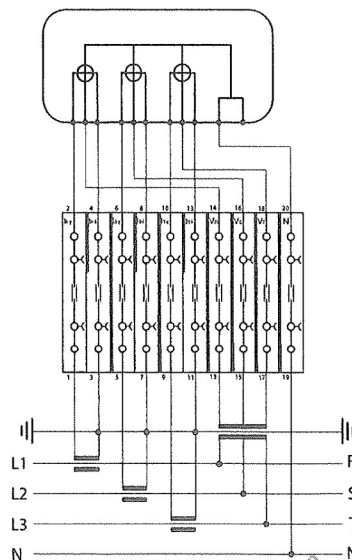

Code No.	Part No.	Applications / Options	Weight	Packing	V	mm ²	A
549206	UF 10E-6I-4T-EPI	Unión Fenosa	516	1-40	600	6	32

ВАРНО С ОРИГИНАЛА

kWh-METER TESTING UNITS

with 2 current terminals per phase for 4 mm Ø insulated test plugs



10E 6I-4T EPI



Test Block Unit for current and voltage circuits with 2 elements per phase on the current circuit, removable jumper plugs.

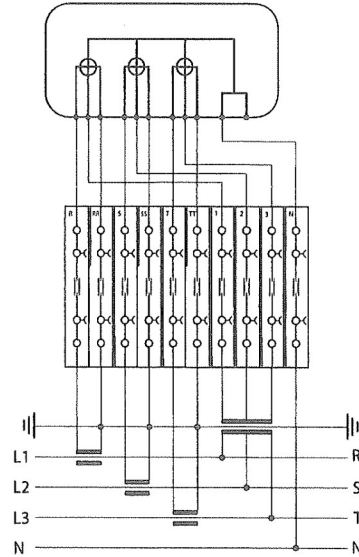
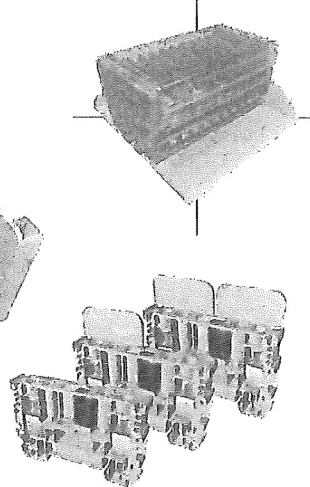
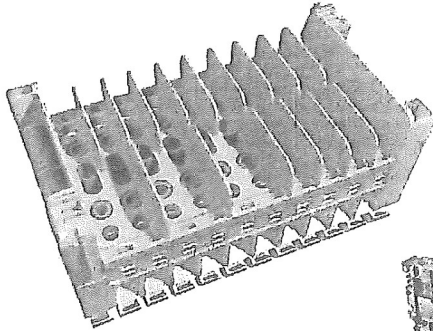
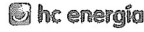

800V 16mm² 76A
EN 60947-7-1

Code No.	Part No.	Applications / Options / Accepted by	Weight	Packing	V	mm ²	A
549265	END 10E-6I-4T-EPI	Endesa	516	1-40	600	6	32
549205	ID 10E-6I-4T-EPI	Iberdrola	516	1-40	600	6	32
549207	EON 10E-6I-4T-EPI	E-ON Viesgo	516	1-40	600	6	32
549208	HC 10E-6I-4T-EPI	Hidroantábrico	516	1-40	600	6	32
549244	REE 10E-6I-4T-EPI	Red Eléctrica de España	516	1-40	600	6	32

10E 6I-4T EPI



Test Block Unit with minimum protection cover for RPM boards.

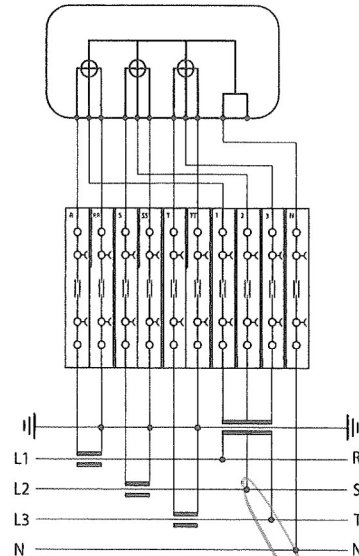
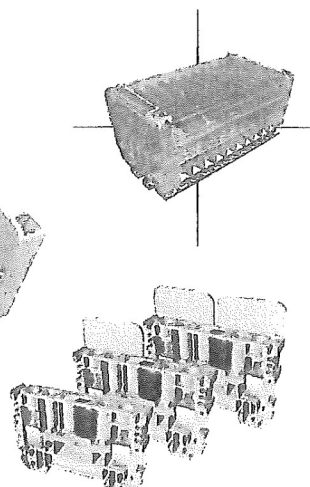
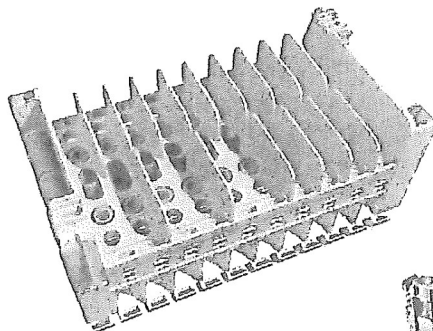

800V 16mm² 76A
EN 60947-7-1

Code No.	Part No.	Applications / Options	Weight	Packing	V	mm ²	A
549346	END 10E-6I-4T-M EPI	Endesa with minimum protection cover	516	1-40	600	16	32
549327	REE 10E-6I-4T-M EPI	Red Eléctrica de España with minimum protection cover	516	1-40	600	16	32
549349	ID 10E-6I-4T-M EPI	Iberdrola with minimum protection cover	516	1-40	600	16	32

kWh-METER TESTING UNITS

with 2 current terminals per phase for 4 mm Ø insulated test plugs



10E 6I-4T FR EPI



Test Block Unit with over sized extended protection cover to allow space for a rivet fixing system.

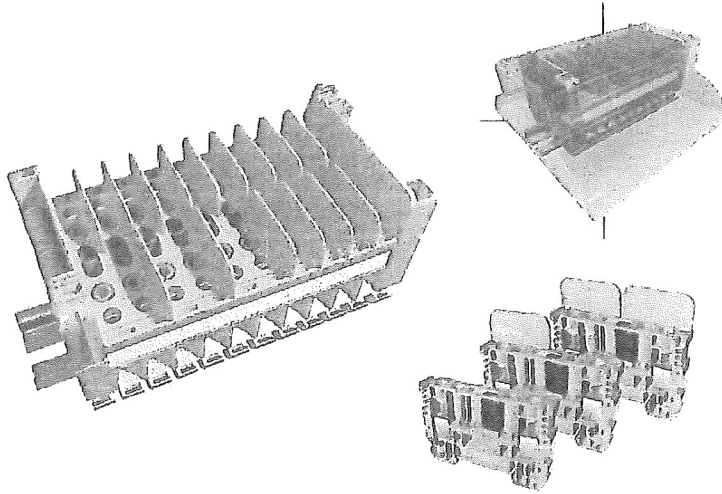

800V 16mm² 76A
EN 60947-7-1

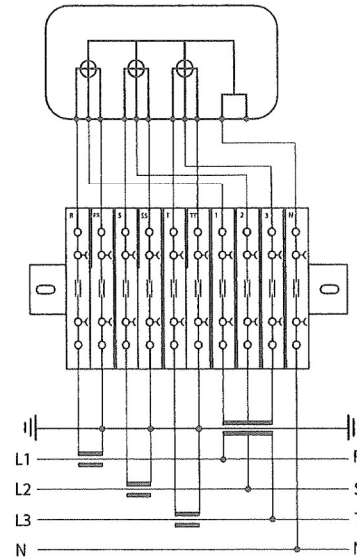

Code No.	Part No.	Applications / Options / Accepted by	Weight	Packing	V	mm ²	A
547206	UF10E-6I-4T-FR EPI	Unión Fenosa	536	1-20	600	6	32
547265	END 10E-6I-4T-FR EPI	Endesa	536	1-20	600	6	32
547205	ID 10E-6I-4T-FR EPI	Iberdrola	536	1-20	600	6	32
547207	EON 10E-6I-4T-FR EPI	E-ON Viesgo	536	1-20	600	6	32
547208	HC 10E-6I-4T-FR EPI	Hidrocarbónico	536	1-20	600	6	32

END 13E 6I-7T-CC EPI



Classic ten elements circuit Test Block Unit with three additional elements for direct connection of grounding wires of the the secondary voltage transformer according to SEVILLANA - ENDESA requirements.

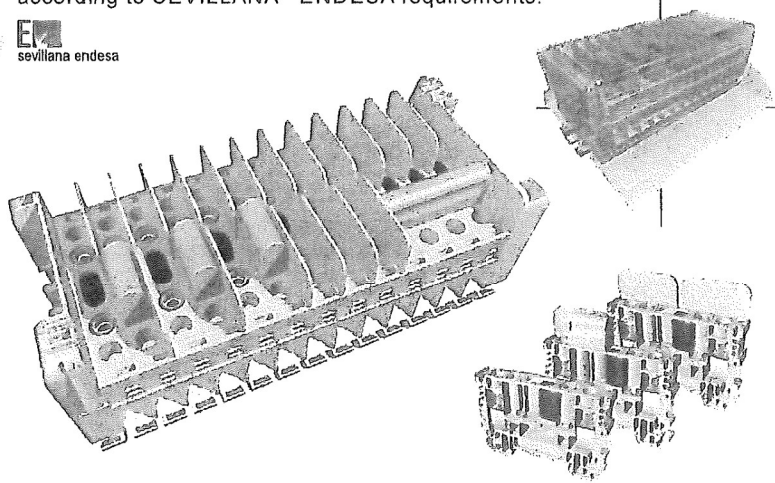

800V 16mm² 76A
EN 60947-7-1

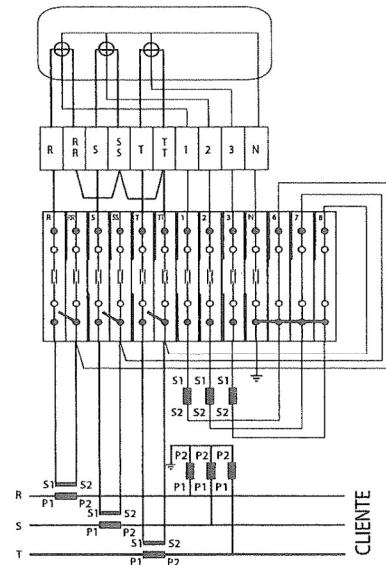

Code No.	Part No.	Applications / Options	Weight	Packing	V	mm ²	A
549310	END 13E 10I-3T-CC EPI	Sevillana-Endesa (caja centralizadora)	652	1-20	600	6	32



kWh-METER TESTING UNITS

with 2 current terminals per phase for 4 mm Ø insulated test plugs



CAT 10E 6I-4T EPI



Test Block Unit with separations between current phases, without cover according to FECSA-ENDESA.

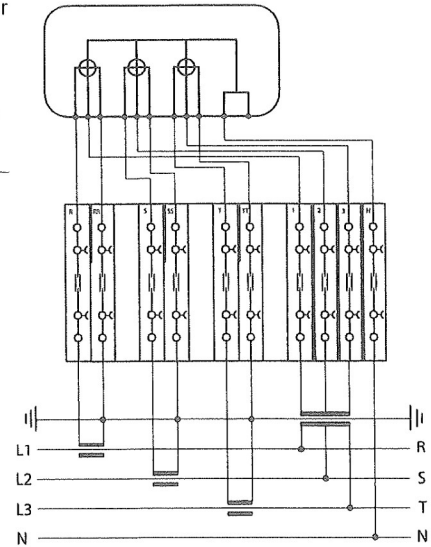
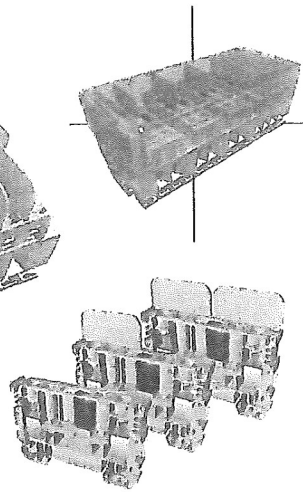
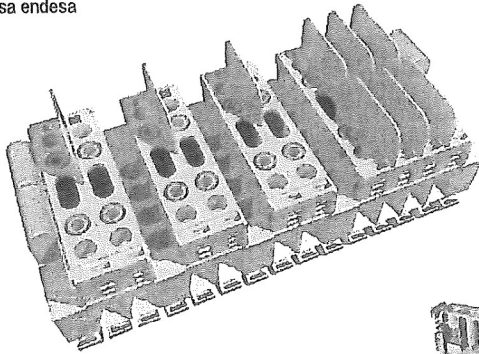

800V 16mm² 76A
EN 60947-7-1

Code No.	Part No.	Applications / Options	Weight	Packing	V	mm ²	A
549209	CAT 10E 6I-4T EPI	Fecsa-Endesa, without protection cover	470	1-24	600	16	32
549360	CAT 10E 6I-4T-M EPI	Fecsa-Endesa, with minimum protection cover	530	1-24	600	16	32

10E 6I-4T+2AUX EPI



Test Block Unit with 10 functional elements plus two additional elements to connect a "Smart metering" modem according to IBERDROLA standard.

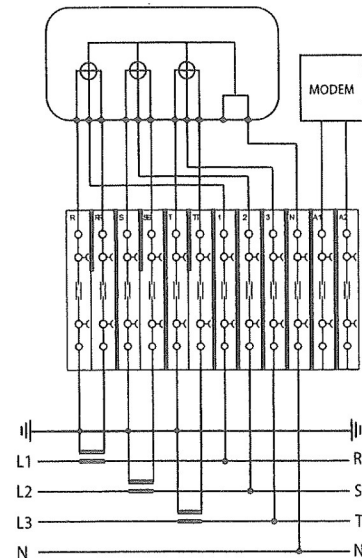
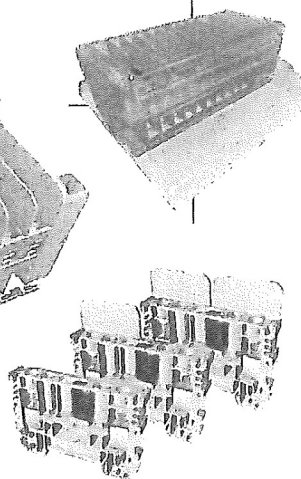
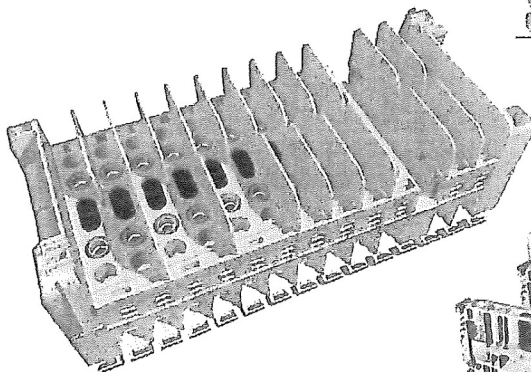

800V 16mm² 76A
EN 60947-7-1

Code No.	Part No.	Applications / Options	Weight	Packing	V	mm ²	A
549246	ID 10E-6I-4T+2AUX EPI	With extended protection cover	618	1-20	600	6	32
549352	UF 10E-6I-4T+2AUX EPI	With extended protection cover	618	1-20	600	6	32

ВЯРНО С ОРИГИНАЛА

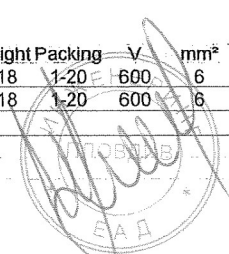

kWh-METER TESTING UNITS

with 3 current terminals per phase for 4 mm Ø insulated test plugs



13E 9I-4T EPI



Test Block Unit with three current elements per phase. Current elements can have perpendicular and longitudinal disconnection. Voltage elements are on the right side of the unit.

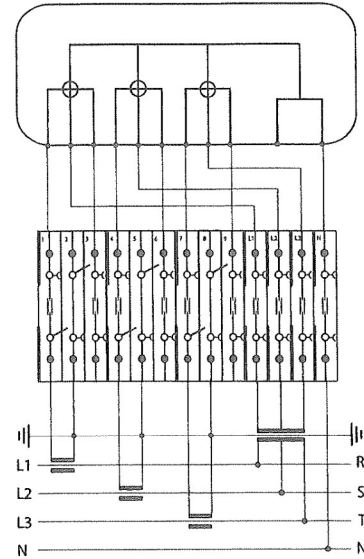
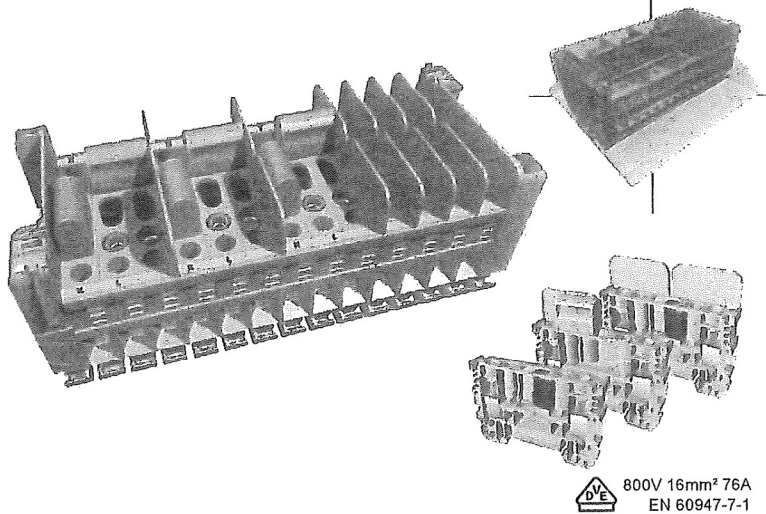

800V 16mm² 76A
EN 60947-7-1

Code No.	Part No.	Applications / Options	Weight	Packing	V	mm ²	A
549329	UNB 13E 9I-4T-A EPI	Extended protection cover	632	1-20	600	6	32
549362	UNB 13E 9I-4T-M EPI	Minimum protection cover	600	1-24	600	16	32

13E 9I-4T-TS EPI



Test Block Unit with three current elements per phase. Current elements can have perpendicular and longitudinal disconnection. Voltage elements are beside each corresponding current phase elements.

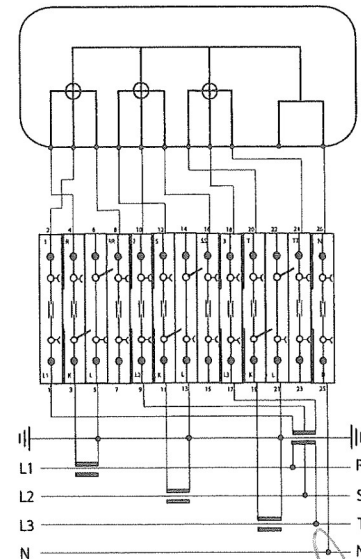
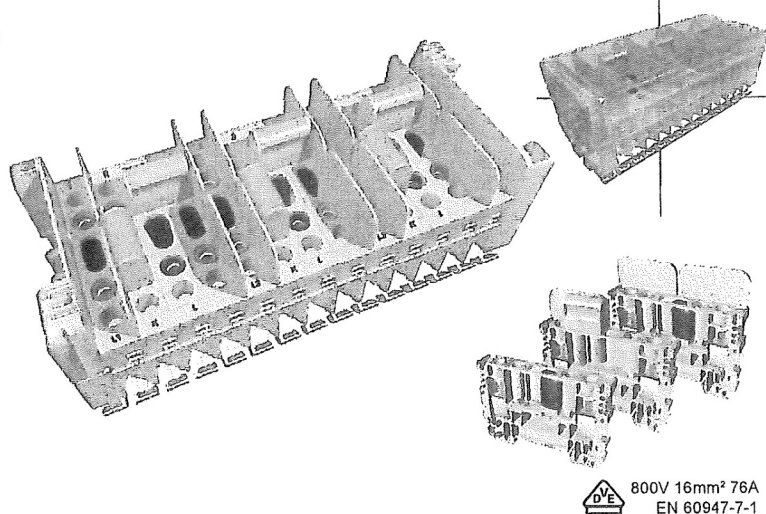

800V 16mm² 76A
EN 60947-7-1

Code No.	Part No.	Applications / Options	Weight	Packing	V	mm ²	A
549319	UNB 13E 9I-4T-TSM EPI	Minimum protection cover, colour sockets	622	1-24	600	16	32
549320	UNB 13E 9I-4T-TSA EPI	Extended protection cover, colour sockets	632	1-20	600	6	32
549309	UNB 13E 9I-4T-TSA EPI	Extended protection cover, orange sockets	632	1-20	600	6	32

ВЯРНО С ОРИГИНАЛА



kWh-METER TESTING UNITS

with 3 current terminals per phase for 4 mm Ø insulated test plugs



14E 9I-4T-1G EPI



Test Block Unit with three current elements per phase. Current elements have perpendicular disconnection only. Voltage elements are on the right side of the unit. Additional earthing terminal block for common

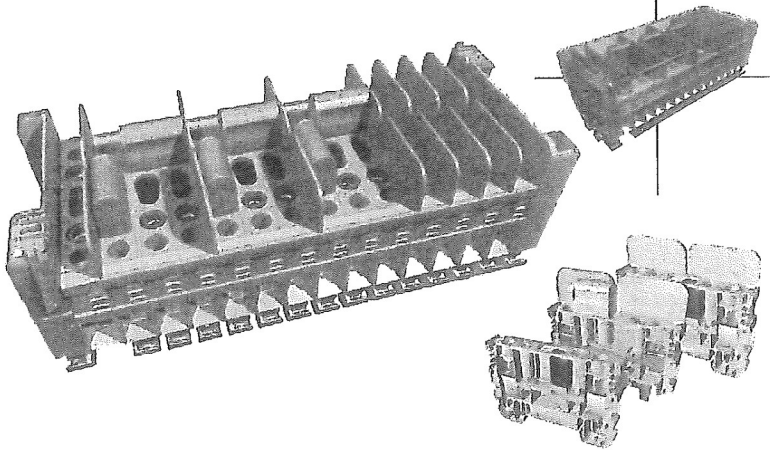

800V 16mm² 76A
EN 60947-7-1

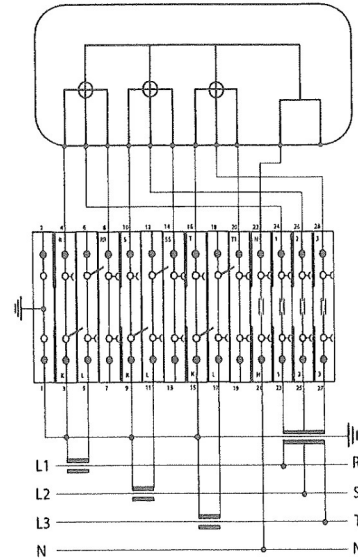

Code No.	Part No.	Applications / Options	Weight	Packing	V	mm ²	A
549321	UNB 14E 9I-4T-1GM EPI	Minimum protection cover	705	1-24	600	16	32

13E 9I-4T-TA EPI



Test Block Unit with three current elements per phase. Current elements have perpendicular disconnection only. Voltage elements are beside each corresponding current phase elements.

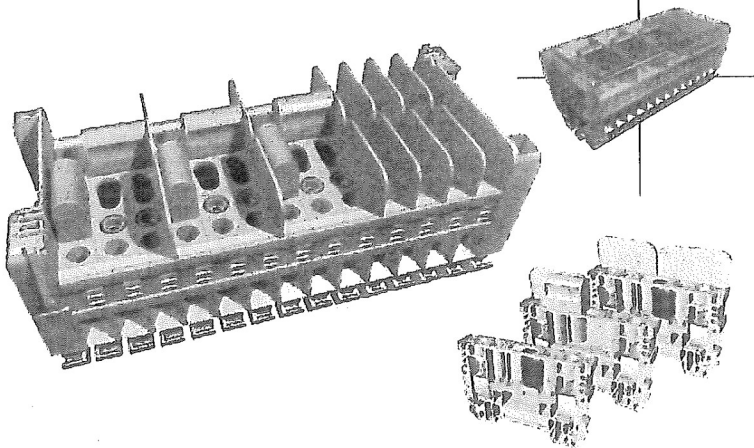

800V 16mm² 76A
EN 60947-7-1

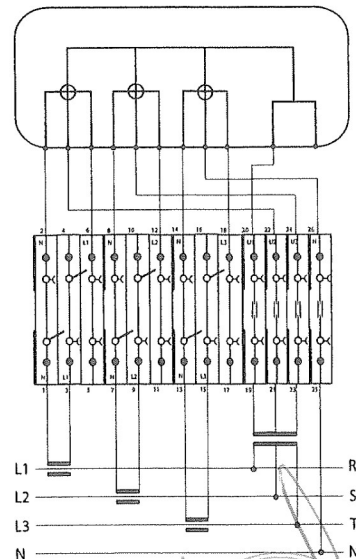

Code No.	Part No.	Applications / Options	Weight	Packing	V	mm ²	A
549387	UNB 13E 9I-4T-TSM EPI	Minimum protection cover, colour sockets	622	1-24	600	16	32
549363	UNB 13E 9I-4T-TSA EPI	Extended protection cover, colour sockets	632	1-20	600	6	32

ВЯРНО С ОРИГИНАЛА

kWh-METER TESTING UNITS

for voltage circuits only and for 4 mm Ø insulated test plugs



4E 4T EPI



Test block Unit for voltage circuits only including one terminal for neutral connection.

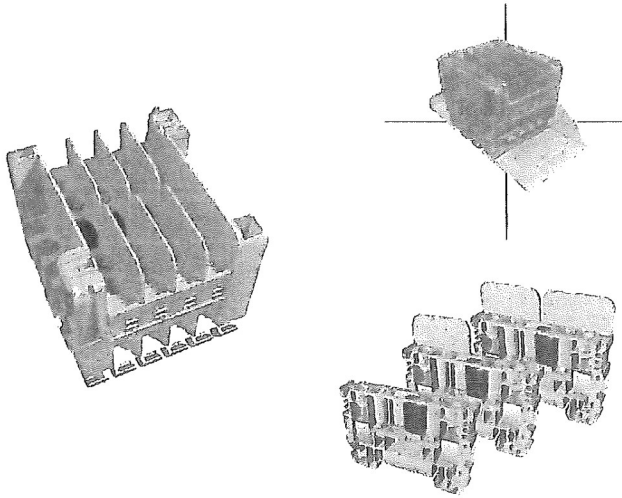

800V 16mm² 76A
EN 60947-7-1

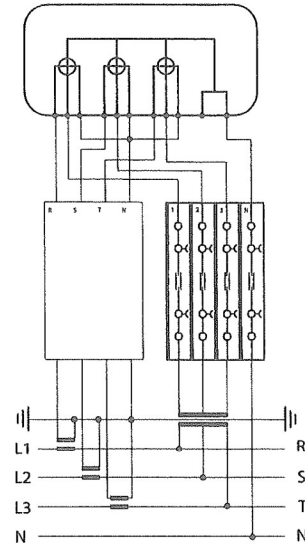

Code No.	Part No.	Applications / Options	Weight	Packing	V	mm ²	A
549388	UNB 4E 4T EPI	4e Extended protection cover	100	1-20	600	6	32
549267	UNB 4E 4T-M EPI	4e Minimum protection cover	80	1-24	600	16	32
549389	UNB 4E 4T-ST EPI	Without protection cover	65	1-24	600	16	32

6E 6T EPI



Test Block Unit for three voltage circuits and three terminals for separate connection of neutral wires.

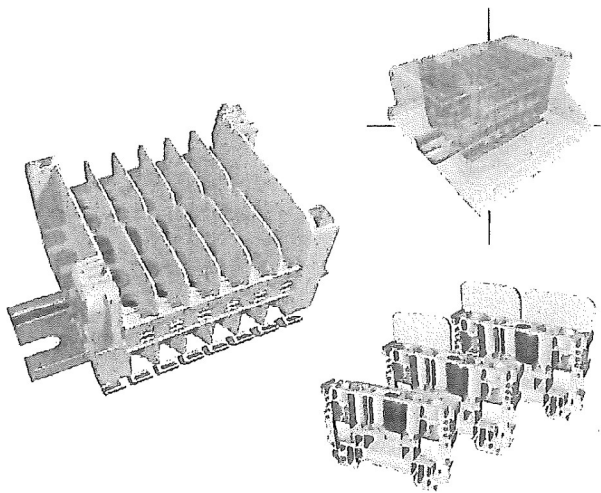

800V 16mm² 76A
EN 60947-7-1

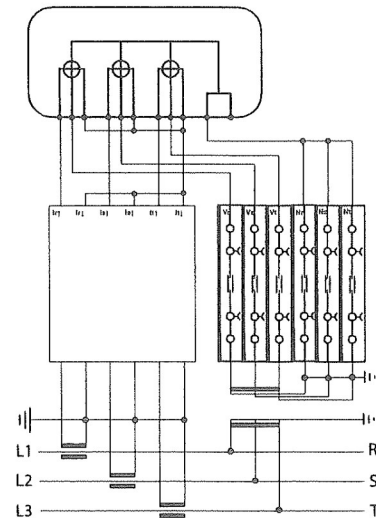

Code No.	Part No.	Applications / Options	Weight	Packing	V	mm ²	A
549307	UF 6E 6T EPI	10e Extended protection cover	100	1-20	600	6	32

ВЯРНО С ОРИГИНАЛА

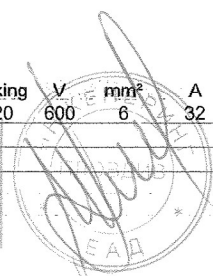

kWh-METER TESTING UNITS

with fuse blocks and for 4 mm Ø insulated test plugs



10E 6I-1N-3FUS EPI



Test Block Unit with 3 fuse elements for voltage circuits.

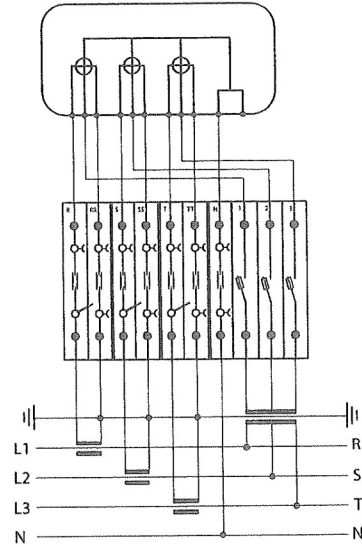
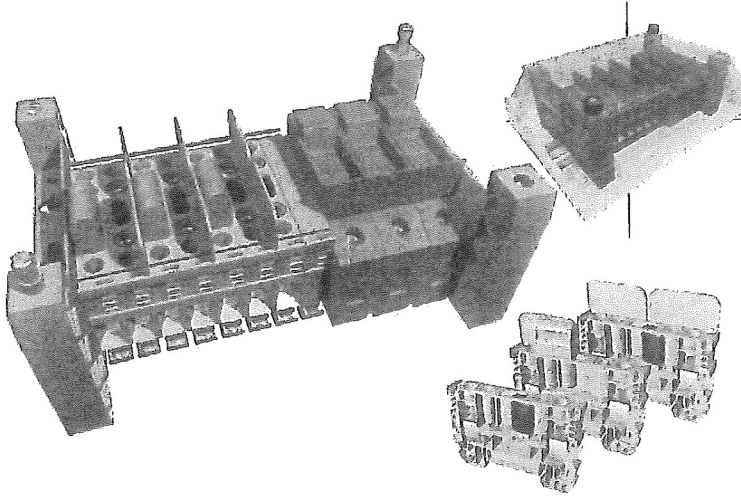

800V 16mm² 76A
EN 60947-7-1

Code No.	Part No.	Applications / Options	Weight	Packing	V	mm ²	A
549302	VID 7E 6I-1T-3FUS EPI	Extended protection grey colour cover	550	1-24	600	16	32
549366	ASTAD 7E 1T-6I-3FUS EPI	Extended protection transparent cover	550	1-24	600	6	32

13E 6I-4T-3FUS EPI



Test Block Unit with 3 additional fuse elements for voltage circuits.

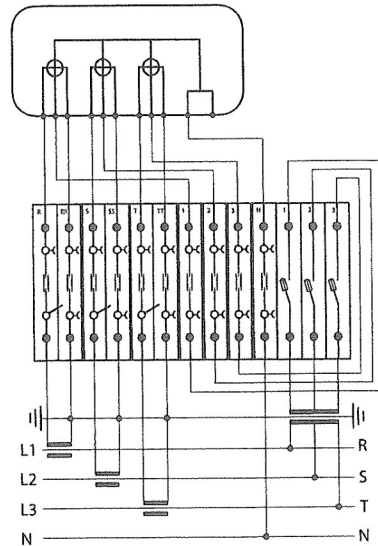
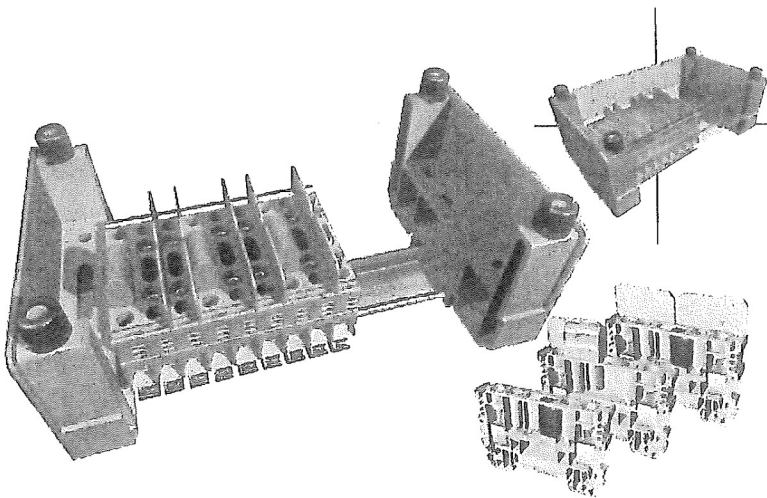

800V 16mm² 76A
EN 60947-7-1

Code No.	Part No.	Applications / Options	Weight	Packing	V	mm ²	A
549365	UNB 10E 6I-4T-3F-TSA EPI	Extended protection cover	650	1-24	600	16	32

ВІРНО С ОРИГІНАЛОМ

446

kWh-METER TEST BLOCK UNITS

Installation Data



OVERALL DIMENSIONS

C6/C16 EXTENDED PROTECTION COVER

MINIMUM PROTECTION COVER

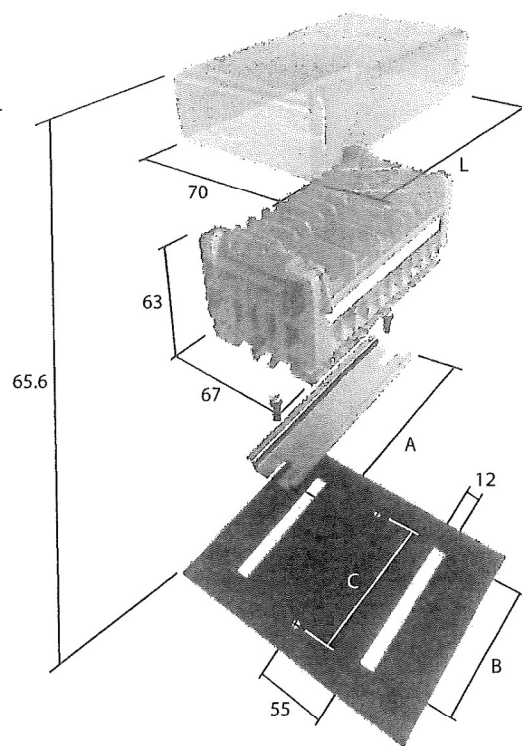
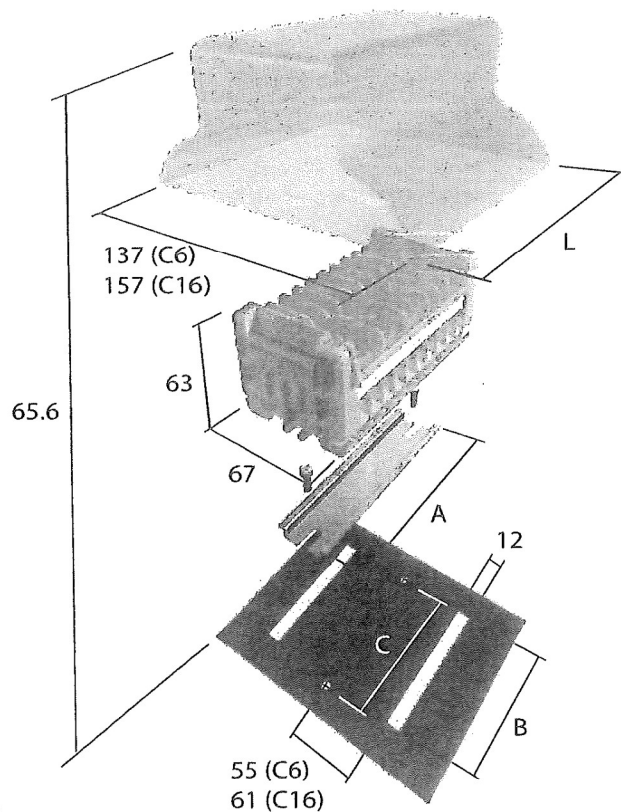

ELEMENT	A	B	C	L
3	53,1	30,1	42,2	53,3
4	63,8	40,8	52,9	64
5	74,5	51,5	63,6	74,7
6	85,2	62,2	74,3	85,3
7	95,9	72,9	85	96
8	106,6	83,6	95,7	106,7
9	117,3	94,3	106,4	117,3
10	128	105	117,1	128
11	138,7	115,7	127,8	138,7
12	149,4	126,4	138,5	149,3
13	160,1	137,1	149,2	160
14	170,8	147,8	159,9	170,7

[Handwritten signature]

ВЯРНО С ОРИГИНАЛА



kWh-METER TEST BLOCK UNITS

Installation DATA

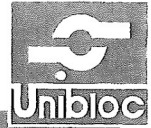

DRILING OPTIONS FOR EXTENDED PROTECTION COVERS AND WIRE CURVES

1 NON DRILLED

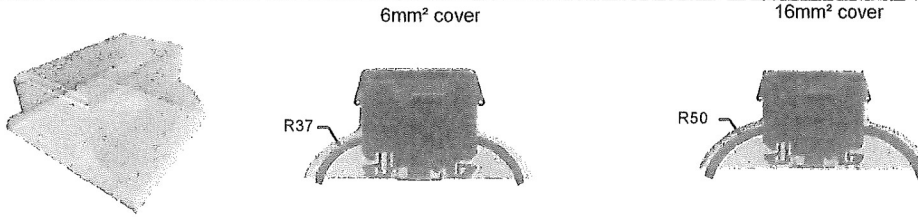

2 ONE SIDE DRILLED

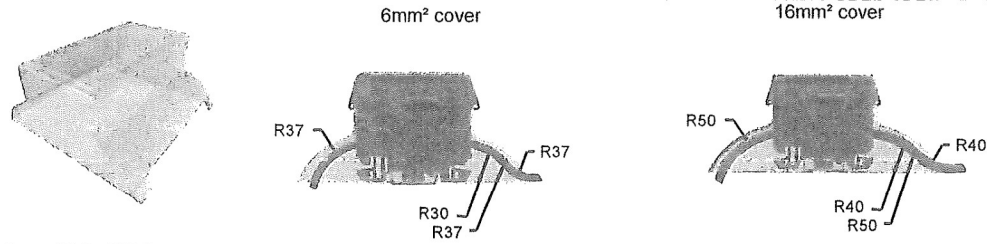

3 BOTH SIDES DRILLED

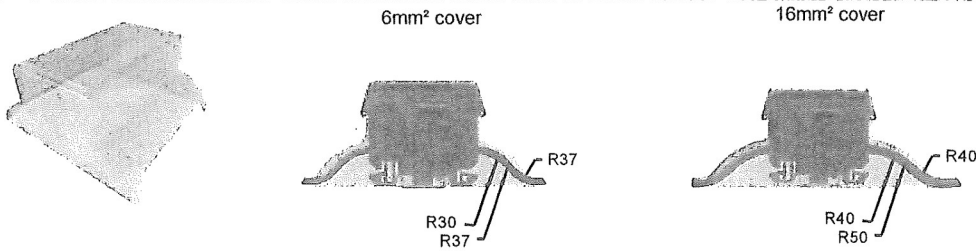

Drilled covers give an IP3XD protection degree according to IEC 60529

TEST BLOCK UNIT LOCATION

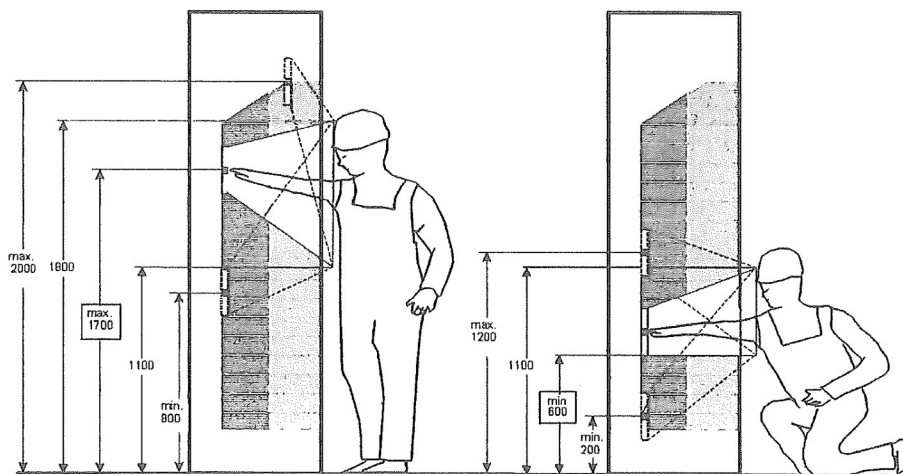

- The Test Block Unit must be placed in such a position that the gravity benefits in opening the circuits. Namely, transformers connections should be on the bottom side, and meter connections should be on the upper side.
- Vertical mounting could be required under some special circumstances. In those occasions, the disconnection system works properly, but the gravity will not affect when opening or closing the circuit.
- Unibloc recommends to place the Test Block Unit at between 600 and 1700 mm high, and at ≤500 mm deep in the cabinet. (see fig. 1 & 2 in EN50274 Standard)

ВЯРНО С ОРИГИНАЛА

448

kWh-METER TEST BLOCK UNITS

Application examples



MEASURING in current circuits with one single element per phase

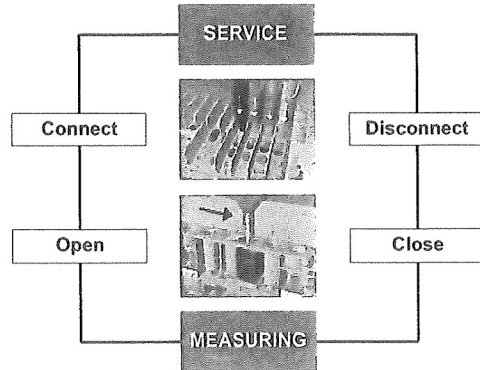
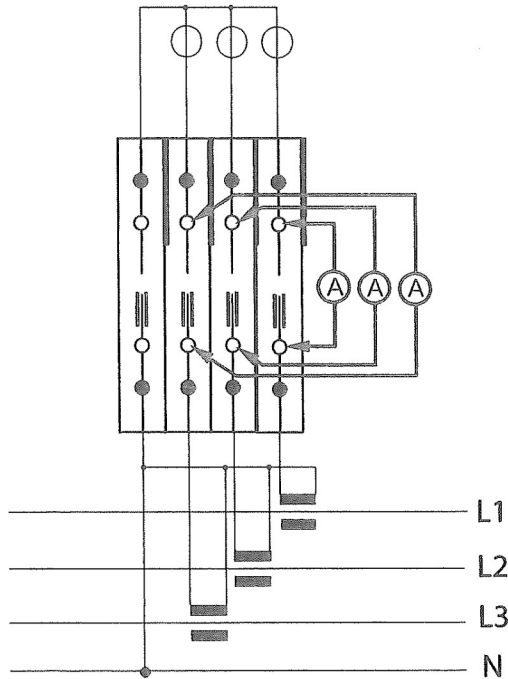

CALIBRATION in current circuits with one single element per phase

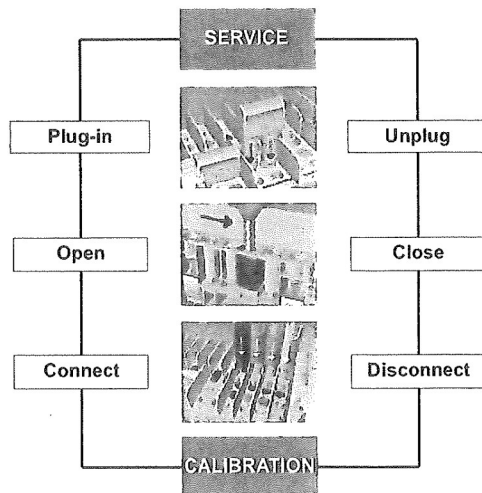
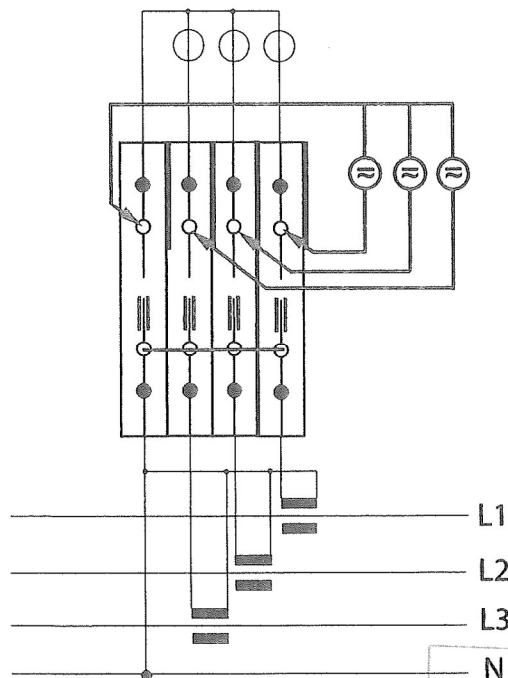

ВЯРНО С ОРИГИНАЛА

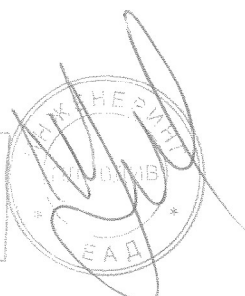

kWh-METER TEST BLOCK UNITS

Application examples



MEASURING in current circuits with two elements per phase

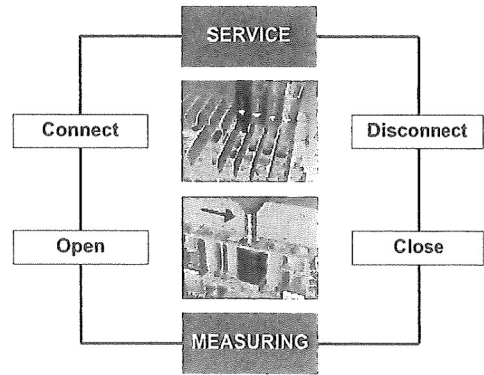
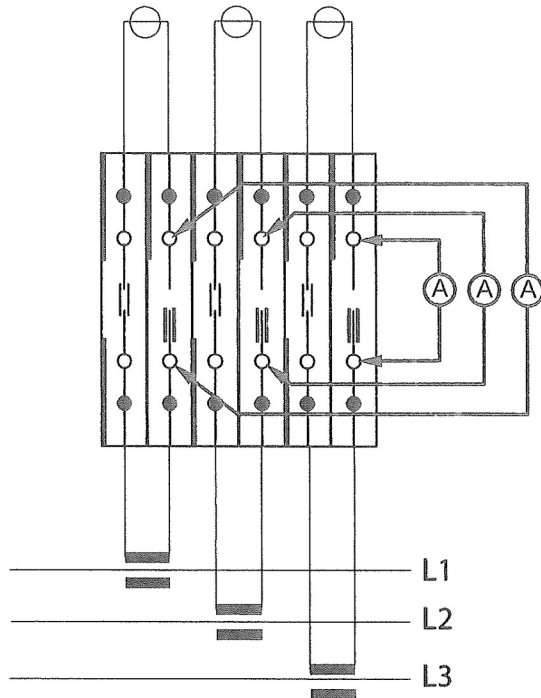

CALIBRATION in current circuits with two elements per phase

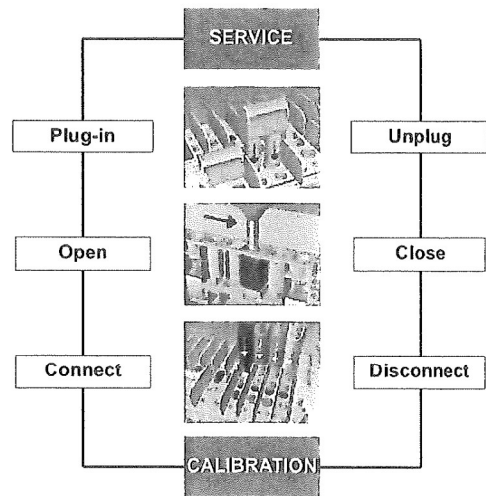
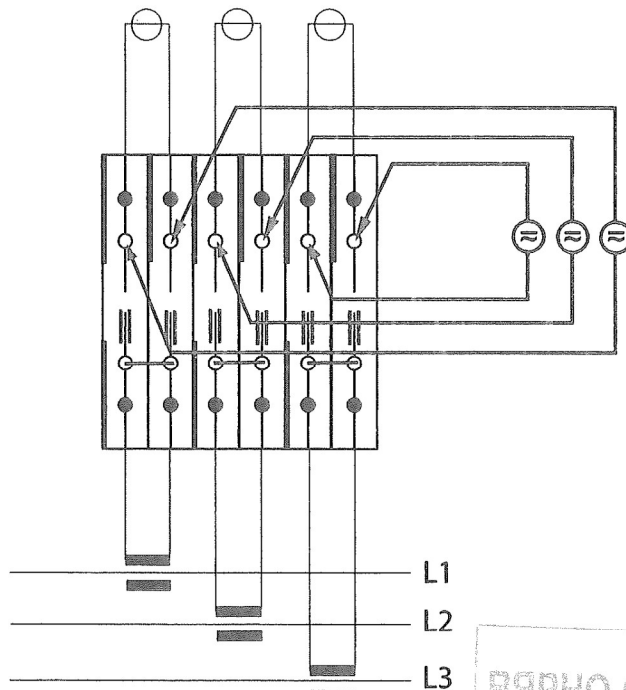

kWh-METER TESTING UNITS

OPERATION PROCEDURES



MEASURING in current circuits with three elements per phase

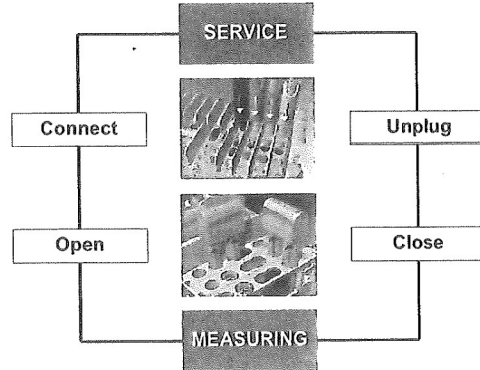
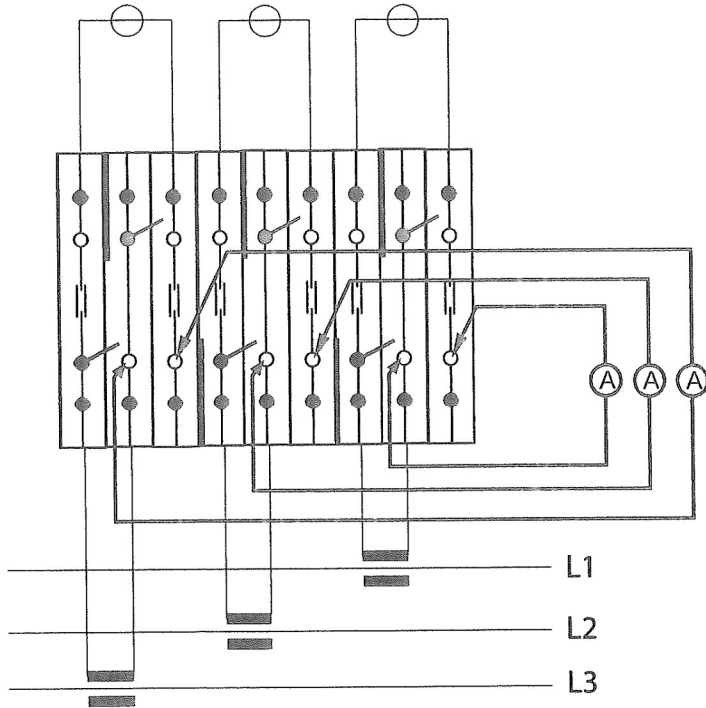

MEASURING in current circuits with three elements per phase

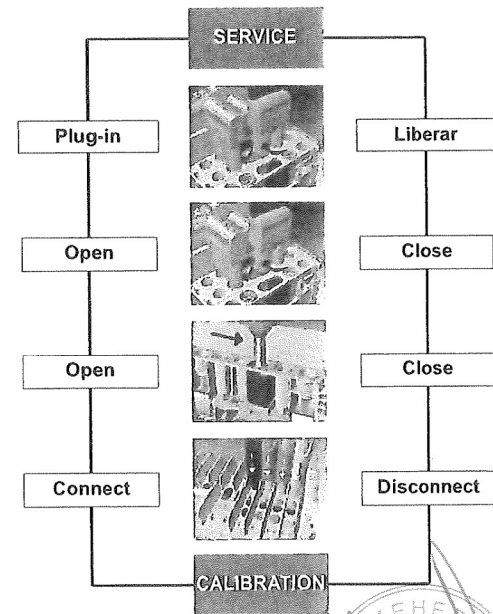
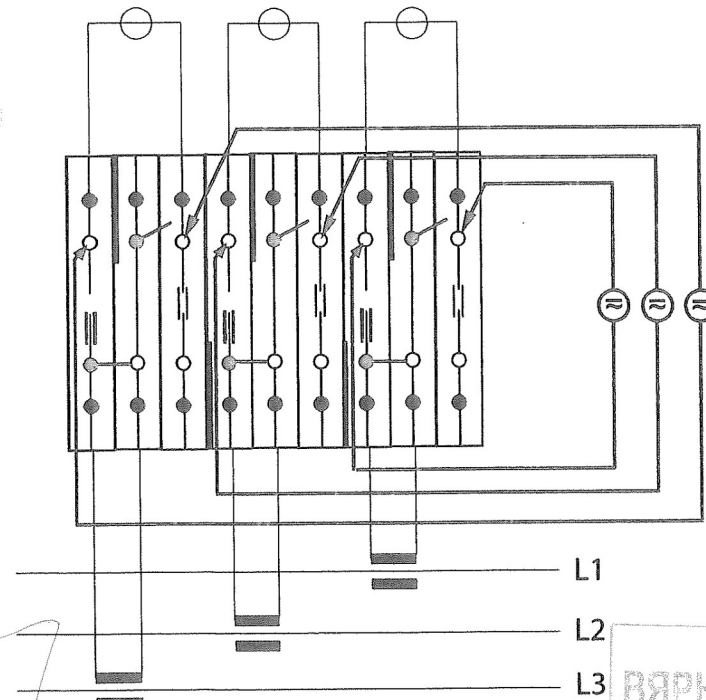

ВЯРНО С ОРИГИНАЛА

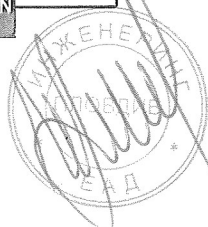

kWh-METER TESTING UNITS

OPERATION PROCEDURES



MEASURING in voltage circuits

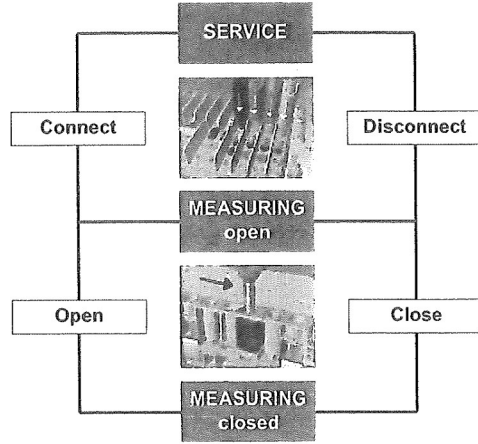
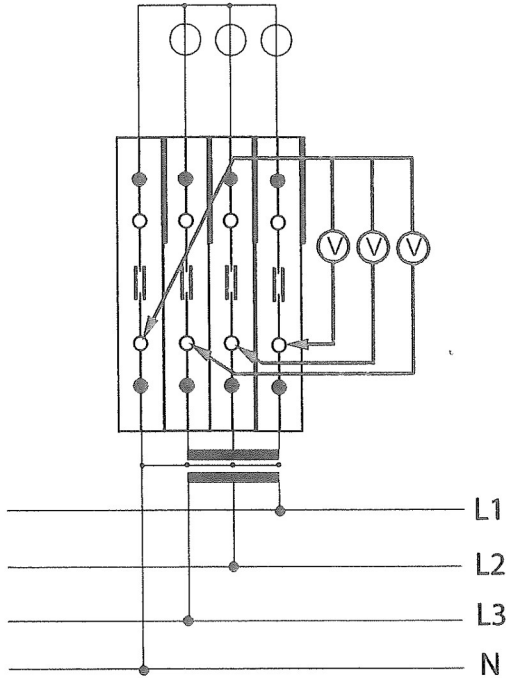

M

CALIBRATION in voltage circuits

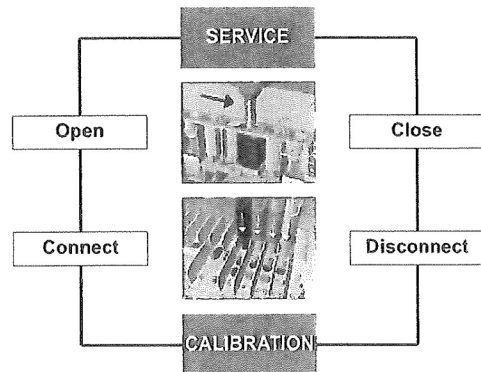
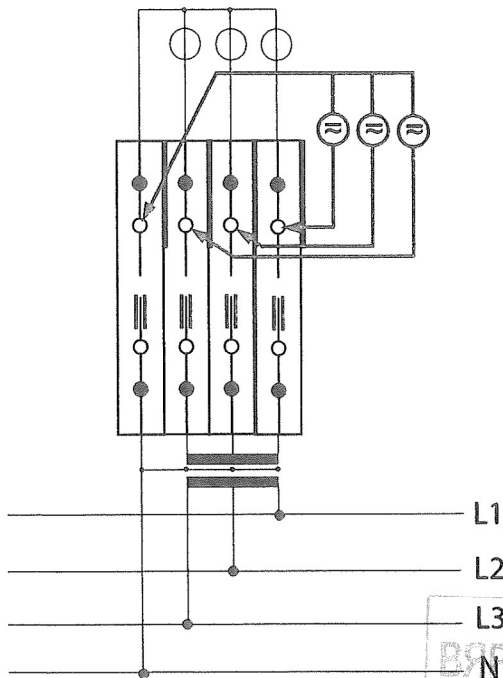

[Handwritten scribble]

ВЯРНО С ОРИГИНАЛА



TECHNICAL DATA

kWh-METER TEST BLOCK UNITS



The main purpose of Unibloc EPI kWh-meter Test Block Units is to "PREVENT RISK". A prior step to prevent any risk is to identify and acknowledge it. Whereby a Test Block unit is to be regarded as an item of electrical equipment to be fitted to a switchgear assembly, the access to such test block unit and its operation being carried out in a routine way and without cutting the energy supply.

IEC 50274 "Low voltage switchgear assemblies. Protection against electric shock. Protection against unintentional direct contact with hazardous live parts" contemplates using (EPI) Individual Safety Equipment to protect health and safety of persons as a last resource, therefore not suitable for switchgear assemblies.

Furthermore, to keep people away from risk by means of screens, barriers or other obstacles would in no case be considered acceptable when checking kWh-meters.

IEC 61140 "Protection against electric shock. Common facts related to installation and equipment", regards as satisfactorily safe the switchgear assemblies that have all accessible devices offering a degree of protection not less than IPxxB accordingly to IEC 60529.

IEC 60947-7-1 "Terminal blocks for copper conductors" sets requirements that are all met by the elements from which our EPI kWh-meter test block units are built. The design of such elements affords additionally the degree of protection IPxxB. However, this is not enough to ensure that "all risk is being avoided" in any given checking job, because the operator may

be using miscellaneous types of probing units to switch his test equipment to the test block unit.

IEC 61010-031 "Safety requirements for hand-held probe assemblies for electrical measurement and test". It sets out that a sufficient insulation can only be obtained when using probes fitted with fixed sleeves, or else that these latter cannot be removed unless using a tool.

Unibloc EPI kWh-meter Test Block Units are so designed as to take insulated test plugs fitted with fixed sleeves, any unintentional contact with live parts during the checking job being thereby prevented. That is of application whether the probes are connected or disconnected, even at their connection or disconnection stages.

Our design is completed with a number of extra features, i.e. easier identification of the connected or disconnected position of any circuit, which also increases safety at all checking operations.

These three suitably combined characteristics (installation, equipment and procedures) make it easier to attain a "safe working environment", as stipulated by the 89/391/CEE Directive concerning the "introduction of measures to encourage improvements in the safety and health of workers at work", as well as by the 89/655/CEE Directive concerning the "minimum safety and health requirements for the use of work equipment by workers at work".

TECHNICAL DATA

TEST BLOCK UNITS

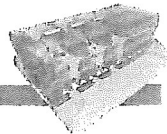

RATED VOLTAGE	600V
RATED CONNECTING CAPACITY	
with extended protection cover C6	1,5..6 mm ² / 2x6 mm ²
with extended protection cover C16	1,5..16 mm ² / 2x6 mm ²
with basic or without protection cover	1,5..16 mm ² / 2x6 mm ²
CURRENT LIMITS	
with standard jumper plugs (T=-5°C..30°C)	32 A
with premium jumper plugs (T=-5°C..30°C)	41 A
without jumper plugs	76 A

APPLICABLE STANDARD: At present is not available an international standard for quality requirements of test block units. Nevertheless IEC is evaluating a proposal submitted by Unibloc to its national subcommittee.

COVERS

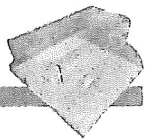

Impact resistance EN 50102	IK08
Cover protection under IEC 60529	
-Extended protection covering: functional parts, external wires, jumper plugs and unit fixing	IP40
-Extended protection with wire openings	IP3XD
-Basic protection covering: functional parts and jumper plugs	IP40
Sun radiation resistance under	EN 60068-2-5 and EN 60068-2-9
Resistance to hot wire ignition	850°C
Material	Polycarbonate

JUMPER PLUGS

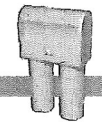

Rated voltage	600V CAT IV
Measuring category IV is for measurements made at the origin of a low voltage installation.	
Dielectric strength test voltage	4,12 kV
Rated impulse withstand voltage	8 kV
Double Insulation fully protected plugs	Class II ☐
Maximal current limits	Standard Premium
- environment temperature -5 °C ..+30 °C	32A 41A
- environment temperature -5 °C ..+40 °C	24A 32A
- environment temperature -5 °C ..+60 °C	14A 20A

• Environment testing conditions: relative humidity 80%, sea level elevation 2000 m, pollution degree 2.

Applicable standard: IEC 61010-031

MATERIALS

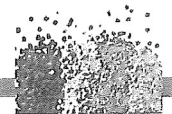

Polymeric materials	
Insulation:	Co-Polyamide 6/6.6
Flame resistant as per UL94	V0
Resistance to hot wire ignition - EN 60695-2-11:	960°C
Temperature at continuous operation - UL 746B:	115°C
Minimum working temperature:	-20°C
Tracking index UL 746A:	>600V / Gado 0
Dielectric strength:	17 kV/mm
Chemical resistant to:	
solvents, lubricants, fuels, refrigerants, salts and alkalis.	
Metallic materials	
Contacts, conductor bar:	Electrolytic copper, tin plated
Contacts, disconnect device:	Electrolytic copper, tin plated
Sockets for inserting plugs:	58 % copper alloy, tin plated
Screws:	Steel with Cr III coating
Clamping units:	Hardened steel with Cr III coating

TECHNICAL DATA

TERMINAL BLOCKS

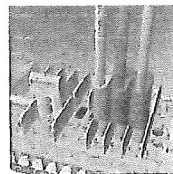
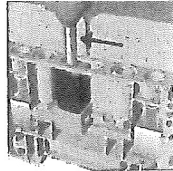
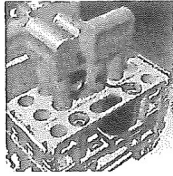

IEC 60947-7-1:2009 is the applicable version of the standard for test disconnect terminal blocks

- RB8 Series has been designed to meet the requirements of this new version of IEC 60947-7-1.
- Such new version of the Standard includes a complete annex with the additional requirements for test disconnect terminal blocks, which cover terminal blocks with longitudinal disconnection (between input and output) and/or perpendicular disconnection (between one terminal block and its adjoining blocks), also make it possible to configure or freely introduce some of the features that are already established by the standard specification for the feed through terminal blocks.
- IEC 60947-7-1:2009 Standard covers three disconnection methods, i.e. plug in, knife type and sliding link.
- Additionally the RB8 Series incorporates Earthing terminal blocks accordingly to IEC 60947-7-2 standard.

Ultra compact design affording maximum heat efficiency (I_{th}):

- Its 10,5 mm. pitch allows for a 16 mm² rated connecting capacity (single core, stranded or stranded fitted with cable terminal) and a 76 A test current accordingly to IEC 60947-7-1 standard. Voltage drop is lower than 0,8 mV with a 5 Amp current.

FULL PROTECTION:

- Insulated sockets for 4 mm Ø test plugs afford an IP20 degree of protection. They also take sleeve insulated test rods to be used under operating voltages up to 600V, accordingly to IEC 61010-031 standard, which makes easier checking or testing procedures under tension. Strict fulfillment of European rules and regulations covering Precautions against Worker's Risk is thereby ensured.

Easy handling:

- The 10,5 mm. pitch enables insertion of standard insulated test plugs easily found at the market. No interference when inserted at the same time in adjoining terminal blocks.

TECHNICAL DATA

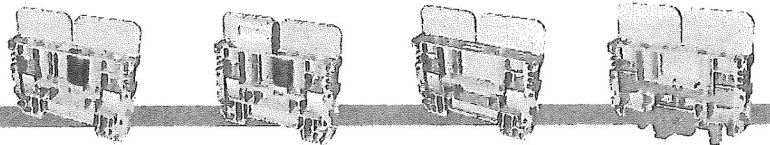

TERMINAL BLOCKS

	RB8	RB8-P	RB8-SS	RBT8
Applicable standard	IEC 60947-7-1 (D)	IEC 60947-7-1 (D)	IEC 60947-7-1	IEC 60947-7-2
Rated insulation Voltage (U _i)	800 V	800 V	800 V	800 V
Rated impulse withstand & Cat. Voltage	8 kV CAT IV	8 kV CAT IV	8 kV CAT IV	8 kV CAT IV
Dielectric strength test voltage	2,2 kV	2,2 kV	2,2 kV	2,2 kV
Pollution degree / Material group	3 / I	3 / I	3 / I	3 / I
Connecting range with 1 wire	0,75..16 mm ²	0,75..16 mm ²	0,75..16 mm ²	0,75..16 mm ²
Connecting range with 2 wire	1,5..6 mm ²	1,5..6 mm ²	1,5..6 mm ²	1,5..6 mm ²
Stripping length	12 mm	12 mm	12 mm	12 mm
Rated cross-section	16 mm ²	6 mm ²	16 mm ²	10 mm ²
Test current on longitudinal current line	76 Amp	41 Amp	76 Amp	57 Amp
Perpendicular test / free air thermal current (I _{th})	-	32 / 41 Amp	-	-
Short time withstand test current	1920 Amp	720 Amp	1920 Amp	1200 Amp
Tightening torque	1,2...1,5 Nm	1,2...1,5 Nm	1,2...1,5 Nm	1,2...1,5 Nm
Screwdriver head size	5 x 1 mm	5 x 1 mm	-	-
Service life testing cycles	100	100	100	100

OTHER TECHNICAL FEATURES

Pitch (A)	10,5 mm	10,5 mm	10,5 mm	10,5 mm
Width (B)	67 mm	67 mm	67 mm	67 mm
Height on TH 35x7,5 rail without separators (C)	46 mm	46 mm	46 mm	46 mm
Height on TH 35x7,5 rail with separators (C)	61,2 mm	61,2 mm	61,2 mm	61,2 mm
Wire gauge EN 60947-1	A6/B6	A6/B6	A6/B6	A6/B6
Protection degree EN 60947-1	IP20	IP20	IP20	IP20
Voltage drop for I _n = 5 Amp	< 0,8 mV	< 0,8 mV	< 0,8 mV	< 0,8 mV
Dielectric strength special test	> 4 kV	> 4 kV	> 4 kV	> 4 kV

- NOTE 1 - "Rated cross section" refers to the selected conductor cross section used for the the evaluation test accordingly to IEC 60947-7-1, setting up the operating limits of the terminal block.
- NOTE 2 - "Connection Capacity or Connecting range" refers to the range of size of the conductors, according to its type and quantity, for which the Rated Insulation Voltage of the terminal block is valid.
- NOTE 3 - Voltage indicated in the Earthing Terminal Blocks means the voltage in respect of the adjacent RB8 terminal blocks.

ASSEMBLING COMPONENTS

IEC 60947-7-1 RB8 SERIES TERMINAL BLOCKS



RB8

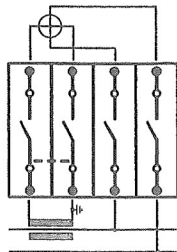

- Test disconnect terminal block with longitudinal disconnection by means of one only M4 screw slide link.
- The type without the socket protection is IP10. Protection should be completed by means of the socket insulators indicated in page 28.
- Perpendicular disconnection is done by means of short-circuit jumper plugs indicated in page 28.

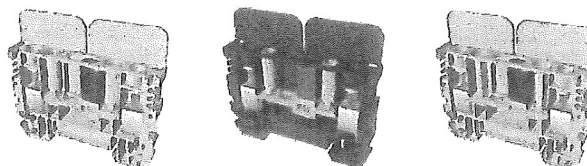

ORDERING DATA

Weight
Packing
Without partition wall
With 2 LR partition walls
With L left partition wall
With R right partition wall

GREY	COLOUR	UNPROTECTED SOCKET
20g	20g	20g
50	50	50
585315	585365	585319
585335	585375	585339
585345	585385	585349
585325	585395	585329

RB8-P

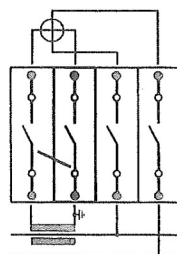

- Test disconnect terminal block with both longitudinal and perpendicular disconnections. The perpendicular link (built-in plug) might be placed before the longitudinal disconnection (sliding link) on model RB8-P1, or it might be placed after it on model RB8-P2.
- This model is protected by the Utility Model patent U200801385.

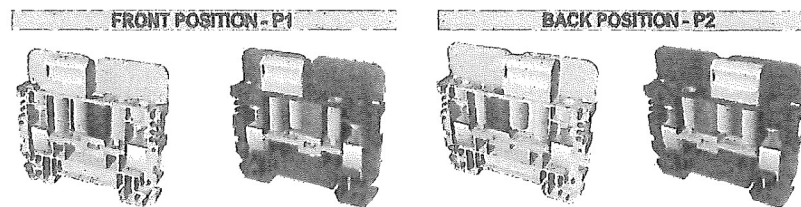

ORDERING DATA

Weight
Packing
Without partition wall
With 2 LR partition walls
With L left partition wall
With R right partition wall

GREY	COLOUR	GREY	COLOUR
26g	26g	26g	26g
50	50	50	50
585314	585364	585313	585363
585334	585374	585333	585373
585344	585384	585343	585383
585324	585394	585323	585393

RB8-SS

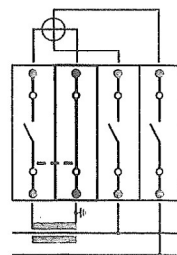

- Feed through terminal block to combine with RB8 test disconnect terminal blocks.
- The type without the socket protection is IP10. Protection should be completed by means of the socket insulators indicated in page 28.
- Perpendicular disconnection is done by means of short-circuit jumper plugs indicated in page 28.

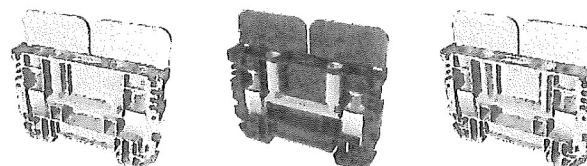

ORDERING DATA

Weight
Packing
Without partition wall
With 2 LR partition walls
With L left partition wall
With R right partition wall

GREY	COLOUR	UNPROTECTED SOCKET
18g	18g	17g
50	50	50
585317	585367	585360
585337	585377	585370
585347	585387	585380
585327	585397	585390



ASSEMBLING COMPONENTS

IEC 60947-7-1 RB8 SERIES TERMINAL BLOCKS



RB8-SS-P

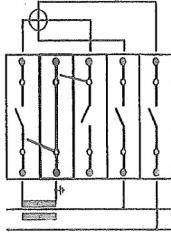

- Test disconnect terminal block with built-in perpendicular disconnection. In combination with an adjacent RB8 or RB8-SS of the same polarity the disconnection becomes in longitudinal type.
- The disconnection link (built-in plug) might be placed at any side of the terminal block.

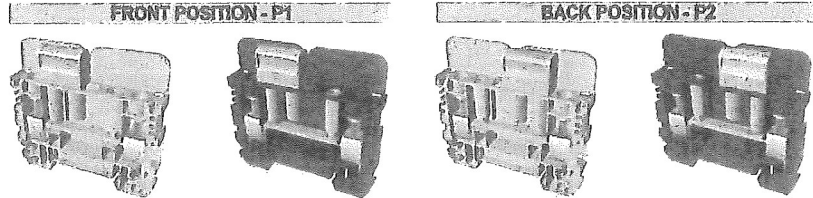

ORDERING DATA

Weight
Packing
Without partition wall
With 2 LR partition walls
With L left partition wall
With R right partition wall

FRONT POSITION - P1		BACK POSITION - P2	
GREY	COLOUR	GREY	COLOUR
24g	24g	24g	24g
50	50	50	50
585312	585362	585316	585366
585332	585372	585336	585376
585342	585382	585346	585386
585322	585392	585326	585396

RBT8

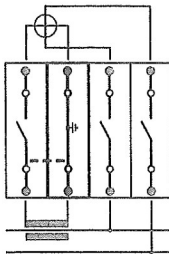

- Earthing terminal block, according to EN 60947-7-2 standard.
- Perpendicular disconnection is done by means of short-circuit jumper plugs indicated in page 28.
- To be fixed to the TH 35x7,5 rail, according to the EN 60715 standard, with any type of material (steel, copper or aluminium)

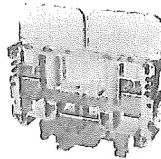

ORDERING DATA

Weight
Packing
Without partition wall
With 2 LR partition walls
With L left partition wall
With R right partition wall

Yellow/Green			
g			
50			
-			
585355			
-			
-			

RBT8-P

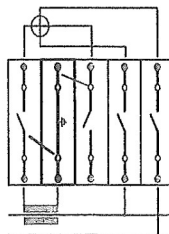

- Hybrid terminal block, for earthing purpose according to the EN 60947-7-2 and test disconnecting according to the EN 60947-7-1 standard, annex D, by means of the built-in perpendicular link.
- To be fixed to the TH 35x7,5 rail, according to the EN 60715 standard, with any type of material (steel, copper or aluminium)

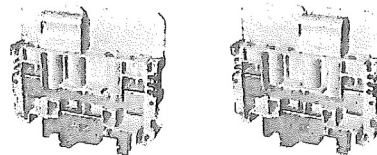

ORDERING DATA

Weight
Packing
Without partition wall
With 2 LR partition walls
With L left partition wall
With R right partition wall

FRONT POSITION - P1		BACK POSITION - P2	
g		g	
50		50	
-		-	
585352		585356	
-		-	

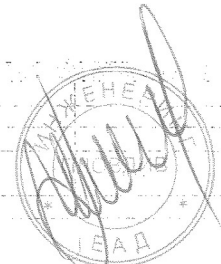

ASSEMBLING COMPONENTS

IEC 61010-031 JUMPER PLUGS & TEST PLUGS



JUMPER PLUGS IEC 61010-031

Code No.	Part No.	Weight	Packing	Poles	Voltage	Current	Pitch
542473	ECD600-2P	6 g	10	2	600V CAT IV	32 A	10.5 mm
542474	ECD600-41	6 g	10	2	600V CAT IV	41 A	10.5 mm
542475	ECD600-4P	15 g	10	4	600V CAT IV	32 A	10.5 mm

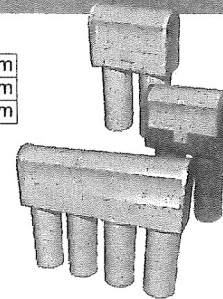

ONE POLE TEST PLUGS IEC 61010-031

Code No.	Part No.	Weight	Packing	Cross section	Size	Current	Pitch
522220	UMF/2.5 BG	6 g	10	2.5 mm ²	∅ 4 mm	32 A	10 mm
522221	UMF/2.5 BL	6 g	10	2.5 mm ²	∅ 4 mm	32 A	10 mm
522222	UMF/2.5 YG	6 g	10	2.5 mm ²	∅ 4 mm	32 A	10 mm
522223	UMF/2.5 GN	6 g	10	2.5 mm ²	∅ 4 mm	32 A	10 mm
522224	UMF/2.5 YW	6 g	10	2.5 mm ²	∅ 4 mm	32 A	10 mm
522225	UMF/2.5 GR	6 g	10	2.5 mm ²	∅ 4 mm	32 A	10 mm
522226	UMF/2.5 OG	6 g	10	2.5 mm ²	∅ 4 mm	32 A	10 mm
522227	UMF/2.5 BK	6 g	10	2.5 mm ²	∅ 4 mm	32 A	10 mm
522228	UMF/2.5 RD	6 g	10	2.5 mm ²	∅ 4 mm	32 A	10 mm
522229	UMF/2.5 PL	6 g	10	2.5 mm ²	∅ 4 mm	32 A	10 mm



TEST PLUG COMBS IEC 61010-031

Code No.	Part No.	Weight	Packing	Cross section	Current	Width	Length
522051	UMF/2.5 L0.5 BL	-	1	2.5 mm ²	32 A	10 mm	0.5 m
522101	UMF/2.5 L1.0 BL	-	1	2.5 mm ²	32 A	10 mm	1.0 m
522151	UMF/2.5 L1.5 BL	-	1	2.5 mm ²	32 A	10 mm	1.5 m
522201	UMF/2.5 L2.0 BL	-	1	2.5 mm ²	32 A	10 mm	2.0 m
522053	UMF/2.5 L0.5 GN	-	1	2.5 mm ²	32 A	10 mm	0.5 m
522103	UMF/2.5 L1.0 GN	-	1	2.5 mm ²	32 A	10 mm	1.0 m
522153	UMF/2.5 L1.5 GN	-	1	2.5 mm ²	32 A	10 mm	1.5 m
522203	UMF/2.5 L2.0 GN	-	1	2.5 mm ²	32 A	10 mm	2.0 m
522054	UMF/2.5 L0.5 YW	-	1	2.5 mm ²	32 A	10 mm	0.5 m
522104	UMF/2.5 L1.0 YW	-	1	2.5 mm ²	32 A	10 mm	1.0 m
522154	UMF/2.5 L1.5 YW	-	1	2.5 mm ²	32 A	10 mm	1.5 m
522204	UMF/2.5 L2.0 YW	-	1	2.5 mm ²	32 A	10 mm	2.0 m
522055	UMF/2.5 L0.5 GY	-	1	2.5 mm ²	32 A	10 mm	0.5 m
522105	UMF/2.5 L1.0 GY	-	1	2.5 mm ²	32 A	10 mm	1.0 m
522155	UMF/2.5 L1.5 GY	-	1	2.5 mm ²	32 A	10 mm	1.5 m
522205	UMF/2.5 L2.0 GY	-	1	2.5 mm ²	32 A	10 mm	2.0 m
522057	UMF/2.5 L0.5 BK	-	1	2.5 mm ²	32 A	10 mm	0.5 m
522107	UMF/2.5 L1.0 BK	-	1	2.5 mm ²	32 A	10 mm	1.0 m
522157	UMF/2.5 L1.5 BK	-	1	2.5 mm ²	32 A	10 mm	1.5 m
522207	UMF/2.5 L2.0 BK	-	1	2.5 mm ²	32 A	10 mm	2.0 m
522058	UMF/2.5 L0.5 RD	-	1	2.5 mm ²	32 A	10 mm	0.5 m
522108	UMF/2.5 L1.0 RD	-	1	2.5 mm ²	32 A	10 mm	1.0 m
522158	UMF/2.5 L1.5 RD	-	1	2.5 mm ²	32 A	10 mm	1.5 m
522208	UMF/2.5 L2.0 RD	-	1	2.5 mm ²	32 A	10 mm	2.0 m



SOCKET INSULATION

Code No.	Part No.	Weight	Packaging	Colour code	Colour	Internal ∅	External ∅
5853080	A4 BG	0.5 g	100	0	Beige	4 mm	6.5 mm
5853081	A4 BL	0.5 g	100	1	Blue	4 mm	6.5 mm
5853082	A4 YG	0.5 g	100	2	Yellow/Green	4 mm	6.5 mm
5853083	A4 GN	0.5 g	100	3	Green	4 mm	6.5 mm
5853084	A4 YW	0.5 g	100	4	Yellow	4 mm	6.5 mm
5853085	A4 GY	0.5 g	100	5	Grey	4 mm	6.5 mm
5853086	A4 OG	0.5 g	100	6	Orange	4 mm	6.5 mm
5853087	A4 BK	0.5 g	100	7	Black	4 mm	6.5 mm
5853088	A4 RD	0.5 g	100	8	Red	4 mm	6.5 mm
5853089	A4 PL	0.5 g	100	9	Purple	4 mm	6.5 mm

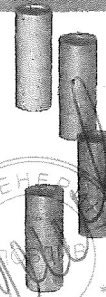

457

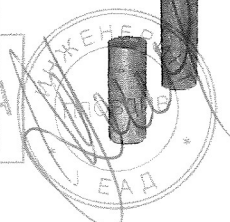

ASSEMBLING COMPONENTS

OTHER ACCESSORIES AND MARKINGS



END BRACKET

Code No.	Part No.	Peso	Embalaje	Espesor	Ancho	Alto
585300	BFRB8	9.5 g	50	10.5 mm	67.0 mm	62.2 mm
585399	BFRB8-SP	8.5 g	50	10.5 mm	67.0 mm	46.0 mm

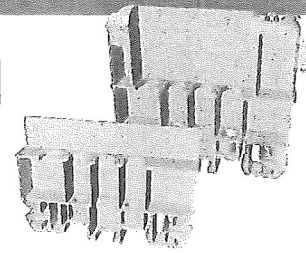

BLANK TERMINAL

Code No.	Part No.	Peso	Embalaje	Espesor	Ancho	Alto
585320	BFRB8 ciega	9.5 g	50	10.5 mm	67.0 mm	62.2 mm

- This part is used as separator between different groups of terminal blocks, for completing the total number of elements in a test block unit for making it suitable for a protection cover with no empty spaces.

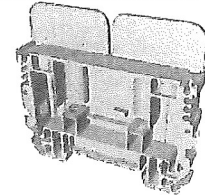

END PLATE

Code No.	Part No.	Weight	Packaging	Thickness	Width	Height
585350	FRB8	3.4 g	20	1.4 mm	67.0 mm	45 mm

- The end plates are for closing and isolating a group of RB8 series elements.
- When being placed between 2 RB8 series elements, the Pitch becomes 12 mm. This is suitable for using the 30 V insulation CLJ jumper plugs from Unibloc.

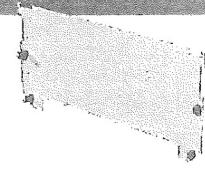

SIDE JUMPER COMBS

Code No.	Part No.	Weight	Packaging	Poles	Section	Current	Pitch
634312	PA RB8/2	3 g	10	2	5.1 mm ²	41 A	10.5 mm
634314	PA RB8/4	6 g	10	4	5.1 mm ²	41 A	10.5 mm
634323	PA RB8/3	5 g	10	3	5.1 mm ²	41 A	21.0 mm
634324	PA RB8/4	6 g	10	4	5.1 mm ²	41 A	21.0 mm

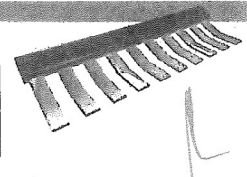

MARKING TAGS

Code No.	Part No.	Weight	Packaging	Size AxB	Printed code no.	Printed pack.
86402004	KAB 5/5.4-5		1430	5.4x5 mm	552001	440
86402006	KAB 5/9-5		1408	9x5 mm	552002	352
86401026	KMR 5/7.5-5		1408	5x7.5 mm	553001	352
86401036	KMR 5/7.5-5		1408	5x7.5 mm	553002	359
551400	KMD 6/9		100	6x9 mm	551490	100

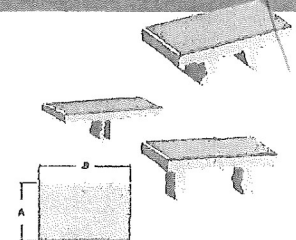

- High quality identification marking tags, halogen free, to be placed by fitting them in each point of the terminal block.
- Large surface for labelling.
- Temperature resistance from -40°C to +140°C
- PC V0 material, white colour.
- They can be delivered already printed by using the Printed code no.

PRINTABLE STRIPS

Code No.	Part No.	Weight	Packaging	Size width	Printed code no.	Printed pack.
5853916	PTR 9.6		150	9.6 mm	585390	150
5853616	PTR 4.9		320	4.5 mm	585360	320

- High quality identification strips, halogen free, to be simultaneously placed in a group of terminal blocks.
- Available in sheets or plates for plotter.
- Very easy and well organised printing by using our "StripLable" software.
- Temperature resistance from -40°C to +140°C
- PVC material, white or yellow colour.
- They can be delivered already printed by using the Printed code no.

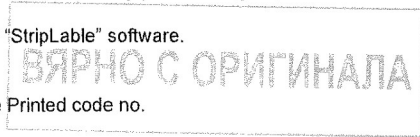

ASSEMBLING COMPONENTS

PROTECTION COVERS



BASIC OR MINIMUM PROTECTION SEALABLE COVERS

	Code No.	Part No.	Elements	Weight	Packing	Drilling	Wire size	Width	Height	Length
<input type="checkbox"/>	538004	ERB8 4E R	4	15 g	1	-	-	80	32	66.5
<input type="checkbox"/>	538010	ERB8 10E R	10	23 g	1	-	-	80	32	130
<input type="checkbox"/>	538013	ERB8 13E R	13	31 g	1	-	-	80	32	164
<input type="checkbox"/>	538014	ERB8 14E R	14	37 g	1	-	-	80	32	175



R

EXTENDED PROTECTION WIRING SEALABLE COVERS

For 6mm²

	Code No.	Part No.	Elements	Weight	Packing	Drilling	Wire size	Width	Height	Length
<input type="checkbox"/>	538110	ERB8 10E CP	10	67 g	1	Non drilled	6 mm ²	138	64	130
<input type="checkbox"/>	538210	ERB8 10E CP-C	10	67 g	1	Cut	6 mm ²	138	64	130
<input type="checkbox"/>	538710	ERB8 10E CP-PT	10	67 g	1	Pre-drilled	6 mm ²	138	64	130
<input type="checkbox"/>	538610	ERB8 10E CP-T	10	65 g	1	Drilled	6 mm ²	138	64	130
<input type="checkbox"/>	538713	ERB8 13E CP-PT	13	76 g	1	Pre-drilled	6 mm ²	138	64	130



CP

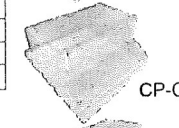

CP-C



CP-PT

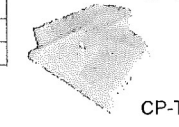

CP-T

For 16mm²

	Code No.	Part No.	Elements	Weight	Packing	Drilling	Wire size	Width	Height	Length
<input type="checkbox"/>	538310	ERB8 10E CP C16	10	70 g	1	Non drilled	16 mm ²	157	64	164
<input type="checkbox"/>	538810	ERB8 10E CP-PT C16	10	70 g	1	Pre-drilled	16 mm ²	157	64	164
<input type="checkbox"/>	538313	ERB8 13E CP C16	13	80 g	1	Non drilled	16 mm ²	157	64	164

Under request, non transparent material

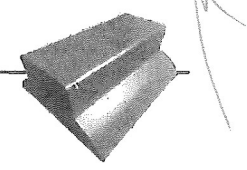

- Dimensions: Width, Height and Length, are in mm.
- Under request, holes might be done for sealing, adapted to any distance for different sizes of the test block units (less than 10 elements). Other drillings and colours might also be supplied under request.
- Different sizes to cover up to 25 terminal blocks can be manufactured under request. Ask for delivery time and minimum order quantity.

[Handwritten signature]

ВЯРНО С ОРИГИНАЛА

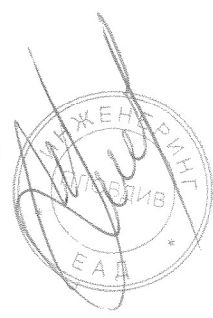

AEF Electric

fuse holders

CYLINDRICAL

df PMX-22
485308 100A
690V~

df PMX-14x51
485208 50A
690V~

df PMX
10x38
32A 690V~
485108

ВЯРНО С ОРИГИНАЛА



СУПЕРРИСА

- PAGE 04 | FUSE HOLDERS
- PAGE 07 | PMX MODULAR FUSE HOLDERS
- PAGE 07 | PMX COMPACT FUSE HOLDERS FOR CC CLASS FUSE-LINKS
- PAGE 07 | PMC COMPACT FUSE HOLDERS
- PAGE 07 | PMX-CC FUSE HOLDERS
- PAGE 07 | PME MODULAR FUSE HOLDERS
- PAGE 08 | PME MODULAR FIXING FUSE HOLDERS
- PAGE 08 | SC SCREEN FUSE BASES
- PAGE 09 | SC OPEN FUSE HOLDERS
- PAGE 09 | BAC OPEN MOUNTING FUSE HOLDERS
- PAGE 09 | PMP PANEL CONNECTION FUSE HOLDERS
- PAGE 10 | PMP PLUG CONNECTION FOR Ø10 FUSE-LINKS
- PAGE 10 | CLIP CONTACT FOR Ø10 FUSE-LINKS

ВЯРНО С ОРИГИНАЛА

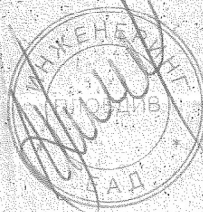

462

CYLINDRICAL FUSE HOLDERS

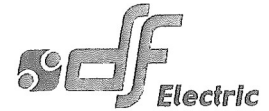

PMX MODULAR FUSE HOLDERS NEW

- Available in a extended range of different versions with fuse indicator, with microswitch, 690V, 24 V DC, Microswitch FUSING+PRE-BREAKING+FUSE LINK DETECTION.
- Accessory available to lock the fuse holder by a padlock.
- IP20 Security accessory in terminal zones. For wires of section $\leq 10 \text{ mm}^2$.
- All the versions with label holder for a good circuit identification.
- Compact design.
- Accessories for multiple poles assembly for fuse holders and microswitch.
- Ventilation zones optimized for a better heat dissipation.

- 2 position DIN Rail fixation.
- Made of a polymer high performance with a fusion temperature more than 300 °C. This provides a safety margin against a possible overheating of the fuse, and when it exceeds the rated power acceptance of the fuse holder.
- The PMX fuse holder can be fixed/unfixed on DIN rail with the same screwing tools that the installer uses for cable terminal fixing, regardless the screw driver head is in form of slot or PZ2.
- PMX Fuse holder is made of halogen free plastic, prepared for future restrictions on these substances.
- IEC (CB) tested.

www.df-sa.es/cylindrical/fuseholders/PMX/

POLES	MODULES	REFERENCE		I _n (A)	U (V)	PACKING Uni / BOX	
		WITHOUT INDICATOR	WITH INDICATOR				
32	1	1	485001	485008	25	400V AC/DC	12/180
	1+N	2	485003	485009	25	400V AC/DC	6/90
	2	2	485004	485010	25	400V AC/DC	6/90
	3	3	485005	485011	25	400V AC/DC	4/60
	3+N	4	485006	485012	25	400V AC/DC	3/45
	4	4	485007	485013	25	400V AC/DC	3/45

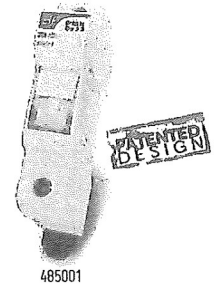

10x38	1	1	485101 c	485108 c	32	690VAC - 750VDC	12/180
	N	1	485102 c	-	32	690VAC - 750VDC	12/180
	1+N	2	485103 c	485109 c	32	690VAC - 750VDC	6/90
	2	2	485104 c	485110 c	32	690VAC - 750VDC	6/90
	3	3	485105 c	485111 c	32	690VAC - 750VDC	4/60
	3+N	4	485106 c	485112 c	32	690VAC - 750VDC	3/45
	4	4	485107 c	485113 c	32	690VAC - 750VDC	3/45

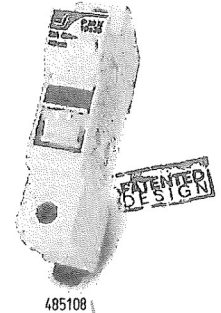

10x38 24VDC	1	1,5	-	485114 c	32	24DC	12
	2	3	-	485116 c	32	24DC	12

PMX MODULAR FUSE HOLDERS ACCESSORIES NEW

REFERENCE	DESCRIPTION	PACKING
480005	PIN FOR MULTIPOLE ASSEMBLY	12
485050	HANDLE TIES FOR MULTIPOLE ASSEMBLY	12
485051	LOCK ACCESSORY	5
485052	SPECIAL IP20 PROTECTION ACCESSORY	24
485053	PHASE SEPARATOR ACCESSORY	12
485054	REPLACEMENT FUSING NEON INDICATOR 120/690V AC	6
485055	REPLACEMENT FUSING LED INDICADOR 24V DC	6
485656	SCREWS PROTECTION ACCESSORY	20



ВЯРНО С ОРИГИНАЛА

STANDARDS	STANDARDS	APPROVALS	TECHNICAL	TECHNICAL	TECHNICAL	TECHNICAL
IEC 60269-1 IEC 60269-2 EN 60269-1 EN 60269-2	CSA 6727/243-1 UL 4243-1	 	TECHNICAL PAGE 11	TECHNICAL PAGE 12	TECHNICAL PAGE 12	TECHNICAL PAGE 14

CYLINDRICAL FUSE HOLDERS

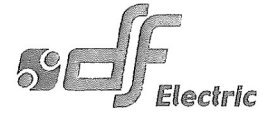

PMX MODULAR FUSE HOLDERS **NEW**

	POLES	MODULES	REFERENCE		I _n (A)	U (V)	PACKING Uni./BOX
			WITHOUT INDICATOR	WITH INDICATOR			
14x51	1	1,5	485201	485208	50	690	6/90
	N	1,5	485202	-	50	690	6/90
	1+N	3	485203	485209	50	690	3/45
	2	3	485204	485210	50	690	3/45
	3	4,5	485205	485211	50	690	2/30
	3+N	6	485206	485212	50	690	1/18
14x51 24VDC	1	1,5	-	485214	50	24	6/90
	1+N	3	-	485215	50	24	3/45
	2	3	-	485216	50	24	3/45

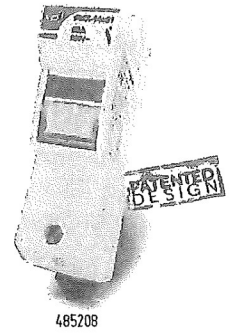

PMX MODULAR FUSE HOLDERS **NEW** WITH MICROSWITCH

	POLES	MODULES	REFERENCE		I _n (A)	U (V)	PACKING Uni./BOX
			PREBREAKING FUSING - PRESENCE	ONLY FUSION			
14x51	1	1,5	485220	485226	50	690	6/90
	1+N	3	485221	485227	50	690	3/45
	2	3	485222	485228	50	690	3/45
	3	4,5	485223	485229	50	690	2/30
	3+N	6	485224	485230	50	690	1/18
	4	6	485225	485231	50	690	1/18

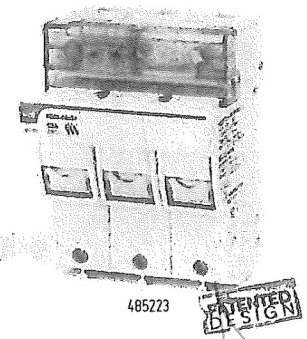

PMX MODULAR FUSE HOLDERS **NEW** ACCESSORIES

REFERENCE	DESCRIPTION	PACKING
480005	PIN FOR MULTIPOLE ASSEMBLY	12
485356	HANDLE TIES FOR MULTIPOLE ASSEMBLY	12
485357	HANDLE TIES FOR MICROSWITCH ASSEMBLY	12
485258	LOCK SUPPORT	5
485259	MICROSWITCH 1P *	5
485260	MICROSWITCH 3P *	2
485261	MICROSWITCH 3P (2M) *	2
485262	MICROSWITCH UNIPOLAR EXTENSION	5
485263	MICROSWITCH TRIPOLAR EXTENSION	2
485264	REPLACEMENT FUSING INDICATOR NEON 120/690 VAC	3
485265	REPLACEMENT FUSING INDICATOR LED 24 VDC	3
485266	SPECIAL PROTECTION IP20 ACCESSORY PMX-14	12
	SPECIAL CONNECTION M6 ACCESSORY	12
485656	SCREW PROTECTION ACCESSORY	12



* TO CONVERT STANDARD BASE ON MICROSWITCH BASE ONLY FUSING AND AS MICROSWITCH PMX SPARE PREBREAKING-FUSING-PRESENCE

ВЯРНО С ОРИГИНАЛА



STANDARDS IEC 60269-1 IEC 60269-2 EN 60269-1 EN 60269-2	STANDARDS CSA C 22.7-243-1 UL 4243-1	APPROVALS 	TECHNICAL TECHNICAL DATA PAGE 11	TECHNICAL PMX FUSE HOLDERS MULTI-POLE ASSEMBLY PAGE 12	TECHNICAL DIMENSIONS PAGE 13	TECHNICAL FUSING INDICATOR ACCESSORY LABEL DIMENSIONS PAGE 14
---------------------------------------------------------------------	--------------------------------------------	-------------------	----------------------------------------	-----------------------------------------------------------------	------------------------------------	---------------------------------------------------------------------------

464

CYLINDRICAL FUSE HOLDERS



PMX MODULAR FUSE HOLDERS

POLES	MODULES	REFERENCE		I _n (A)	U (V)	PACKING Uni./BOX	
		WITHOUT INDICATOR	WITH INDICATOR				
22x58	1	2	485301 c US	485308 c US	100*	690	6/48
	N	2	485302 c US	-	100*	690	6/48
	1+N	4	485303 c US	485309 c US	100*	690	3/24
	2	4	485304 c US	485310 c US	100*	690	3/24
	3	6	485305 c US	485311 c US	100*	690	2/16
	3+N	8	485306 c US	485312 c US	100*	690	1/8
4	8	485307 c US	485313 c US	100*	690	1/8	
22x58 24VDC	1	2	-	485314 c US	100*	24	6/48
	1+N	4	-	485315 c US	100*	24	3/24
	2	4	-	485316 c US	100*	24	3/24

* ACCEPT 125A FUSE-LINKS

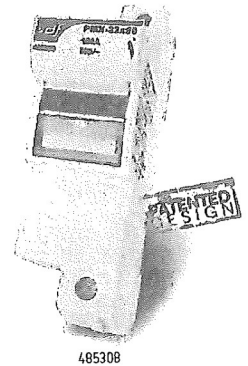

PMX MODULAR FUSE HOLDERS WITH MICROSWITCH

POLES	MODULES	REFERENCE		I _n (A)	U (V)	PACKING Uni./BOX	
		PREBREAKING FUSING - PRESENCE	ONLY FUSION				
22x58	1	2	485320 c US	485326 c US	100*	690	6/48
	1+N	4	485321 c US	485327 c US	100*	690	3/24
	2	4	485322 c US	485328 c US	100*	690	3/24
	3	6	485323 c US	485329 c US	100*	690	2/16
	3+N	8	485324 c US	485330 c US	100*	690	1/8
	4	8	485325 c US	485331 c US	100*	690	1/8

* ACCEPT 125A FUSE-LINKS

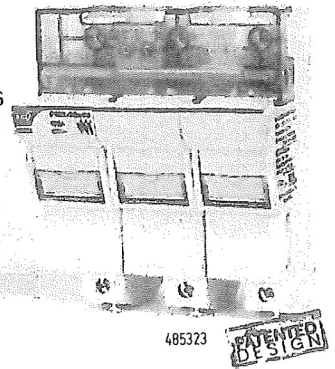

PMX MODULAR FUSE HOLDERS ACCESSORIES

REFERENCE	DESCRIPTION	PACKING
480005	PIN FOR MULTIPOLE ASSEMBLY	12
485356	HANDLE TIES FOR MULTIPOLE ASSEMBLY	12
485357	HANDLE TIES FOR MICROSWITCH ASSEMBLY	12
485358	LOCK SUPPORT	5
485359	MICROSWITCH 1P *	5
485360	MICROSWITCH 3P *	2
485361	MICROSWITCH 3P (2M) *	2
485362	MICROSWITCH UNIPOLAR EXTENSION	5
485363	MICROSWITCH TRIPOLAR EXTENSION	2
485364	REPLACEMENT FUSING INDICATOR NEON 120/690 VAC	3
485365	REPLACEMENT FUSING INDICATOR LED 24 VDC	3
485366	SPECIAL PROTECTION IP20 ACCESSORIE PMX-22	12
485367	SPECIAL CONNECTION M8 ACCESSORY	12

* TO CONVERT STANDARD BASE ON MICROSWITCH BASE ONLY FUSION AND AS MICROSWITCH PMX SPARE PREBREAKING-FUSING-PRESENCE



ВЕРНО С ОРИГИНАЛА

STANDARDS IEC 60269-1 IEC 60269-2 EN 60269-1 EN 60269-2	STANDARDS CSA 22.2/248-1 UL 248-1	APPROVALS IEC RoHS RECYCLED	TECHNICAL TECHNICAL AT PAGE 11	TECHNICAL PMX FUSE HOLDERS MULTI-POLE/SINGLE-POLE PAGE 12	TECHNICAL DIMENSIONS PAGE 13	TECHNICAL PMX FUSE HOLDERS + MICROSWITCH REPLACEMENT FUSING INDICATOR DIMENSIONS PAGE 14
---------------------------------------------------------------------	-----------------------------------------	------------------------------------------	--------------------------------------	--------------------------------------------------------------------	------------------------------------	---------------------------------------------------------------------------------------------------------

CYLINDRICAL FUSE HOLDERS



PMC COMPACT FUSE HOLDERS



Compact fuse holders for industrial cylindrical fuse links. Very low dimensions. For mounting on DIN/EN rail. Single phase models or single phase + neutral in only one module. Multi-pole units can be made with connection accessories. PMC fuse holders are made with self-extinguishable materials and have silver plated copper contacts.

www.df-sa.es/cylindrical/fuseholders/PMC/

	POLES	MODULES 17.5 mm	REFERENCE	I _n (A)	U (V)	PACKING Uni / BOX
8x32	I	1	483500	25	400	12/336
	N	1	483502	32	400	12/336
	I + N	1	483504	25	400	12/336
	I + N	2	483506	25	400	6/168
	2	2	483508	25	400	6/168
	3	3	483510	25	400	4/112
	3 + N	3	483512	25	400	4/112
	3 + N	4	483514	25	400	3/84
	4	4	483516	25	400	3/84
10x38	I	1	483530	32	500	12/336
	N	1	483502	32	500	12/336
	I + N	1	483534	32	500	12/336
	I + N	2	483536	32	500	6/168
	2	2	483538	32	500	6/168
	3	3	483540	32	500	4/112
	3 + N	3	483542	32	500	4/112
	3 + N	4	483544	32	500	3/84
	4	4	483546	32	500	3/84

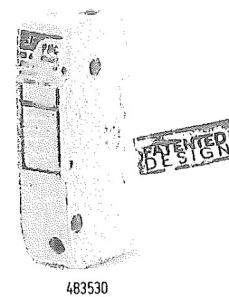

483530

PMC COMPACT FUSE HOLDERS ACCESSORIES

SIZE	REFERENCE	DESCRIPTION	PACKING
8x32 / 10x38	480005	PINS FOR MULTIPOLE ASSEMBLY	12/300
8x32 / 10x38	483550	PMC HANDLE TIES FOR MULTIPOLE ASSEMBLY	12/300
8x32 / 10x38	483552	PMC MULTIPOLE ASSEMBLY KIT	12/300

PMX CC MODULAR FUSE HOLDERS



Modular fuse holders for cylindrical CC class fuse links. For mounting on DIN/EN rail. Single phase and multi-pole types. Available with fusing indicator. Multi-pole units can be made with connection accessories. PMCC fuse holders are made with self-extinguishable materials and have silver plated copper contacts. UL approval.

www.df-sa.es/cylindrical/fuseholders/PMCC/

POLES	REFERENCE WITHOUT INDICATOR	REFERENCE WITH INDICATOR	I _n (A)	U (V)	PACKING Uni / BOX
I	485181 (UL)	485188 (UL)	30	600	12/192
II	485184 (UL)	485190 (UL)	30	600	6/96
III	485185 (UL)	485191 (UL)	30	600	4/64

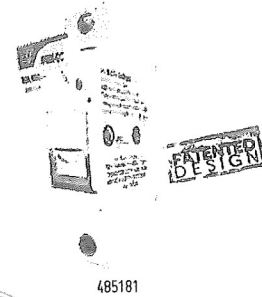

485181

STANDARDS	STANDARDS	APPROVALS
IEC 60269-1 IEC 60269-2 EN 60269-1 EN 60269-2	CSA C22.2/4243-1 UL 4243-1 UL 4243-2	UL RoHS compliant

TECHNICAL DESCRIPTION	TECHNICAL DIMENSIONS
PAGE 11	PAGE 12

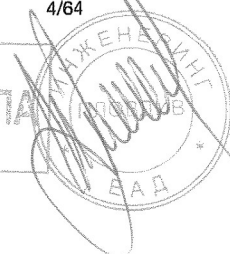

466

CYLINDRICAL FUSE HOLDERS



PMF MODULAR FUSE HOLDERS WITH INTEGRATED NEUTRAL

Modular fuse holders for industrial cylindrical fuse links. For mounting on DIN/EN rail Single phase models, single-phase+neutral in only one module and multi-pole types. Available with fusing indicator or with microswitch for use with fuse links with striker (only fusing detection or fusing+pre-breaking+ fuse link detection). Multi-pole units can be made of connection accessories. PMF fuse holders are made of self-extinguishable materials and have silver plated copper contacts.

www.df-sa.es/cylindrical/fuseholders/PMF/



480032



480135



480005

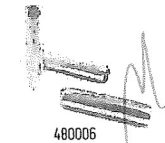

480006



485600



485603



485605

	POLES	MODULES 17.5 mm	REFERENCE		I _n (A)	U (V)	PACKING Uni /BOX
			WITHOUT INDICATOR	WITH INDICATOR			
8x32	1 + N	1	480125	480125 I	25	400	12/192
	3 + N	3	480325	480325 I	25	400	4/64
10x38	I	1	480032	-	32	690	12/192
	N	1	480032 N	-	32	690	12/192
	1 + N	1	480135	480335 I	32	400	12/192
	1 + N	2	480132	-	32	690	6/96
	2	2	480232	-	32	690	6/96
	3	3	480332	-	32	690	4/64
	3 + N	3	480335	-	32	400	4/64
	3 + N	4	480432	-	32	690	3/48
4	4	480532	-	32	690	3/48	

PMF MODULAR FUSE HOLDERS ACCESSORIES

	REFERENCE	DESCRIPTION	PACKING
8x32 10x38	480005	PINS FOR MULTIPOLE ASSEMBLY	12
	480006	HANDLE TIES FOR MULTIPOLE ASSEMBLY	12

PMF CONNECTION ACCESSORIES PHASE BUSBARS NEW

	POLES	MODULES	REFERENCE	SECTION (mm ²)	PACKING
PMF PMX PMC PMCC	I	13	485600	10	10
	I	57	485601	10	10
	II	12	485602	10	6

PMF CONNECTION ACCESSORIES ACCESSORIES FOR PHASE BUSBARS NEW

REFERENCE	DESCRIPTION	PACKING
485603	INSULATED TERMINAL 6...25 mm ² (FEEDING ACROSS)	10
485604	INSULATED TERMINAL 6...50 mm ² (FEEDING ACROSS)	50
485605	END COVER FOR 1 PHASE BUSBAR	50

STANDARDS	APPROVALS
IEC 60269-1 IEC 60269-2 EN 60269-1 EN 60269-2	Rohs compliant (RECYCLED)

TECHNICAL
TECHNICAL DATA
PAGE 11

TECHNICAL
PMF FUSE HOLDERS MULTIPOLE ASSEMBLY
PAGE 12

TECHNICAL
DIMENSIONS
PAGE 17

TECHNICAL
PHASE BUSBARS ACCESSORIES DIMENSIONS
PAGE 21

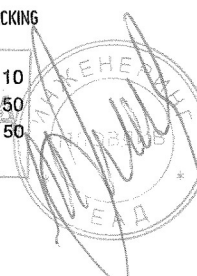



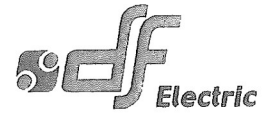

CYLINDRICAL FUSE HOLDERS



SC SCREW FIXING FUSE HOLDERS

Fuse holders for industrial cylindrical fuse links. Screw fixing. Available single-pole and neutrals. SC fuse holders are made with self-extinguishable materials and have silver plated copper contacts.
www.df-sa.es/cylindrical/fuseholders/SC/



	POLES	MODULES 17,5 mm	REFERENCE	I _n (A)	U (V)	PACKING Uni /BOX
	I	1	451025	25	400	12
	N	1	451025 N	25	400	12
	I	1	451032	32	500	12
	N	1	451032 N	32	500	12
	I	1	451050	50	690	12
	N	1	451050 N	50	690	12
	I	1	451100	100	690	6
	N	1	451100 N	100	690	6



451032

BAC OPEN FUSE BASES

Open bases for cylindrical fuses. The bases BAC for cylindrical fuses are particularly suitable for semiconductor fuses with high power dissipation and therefore needed to be mounted on open bases to facilitate the heat dissipation. Fixation on panel by screw. Made of thermosetting self extinguishing material.
www.df-sa.es/cylindrical/fuseholders/BAC/

	REFERENCE	I _n (A)	U (V)	PACKING Uni /BOX
	451210	32	690	20/300
	451220	50	690	10/240
	451230	100	690	10/120

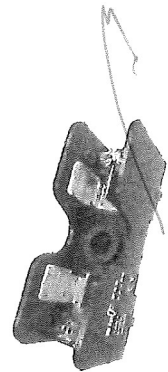

451230

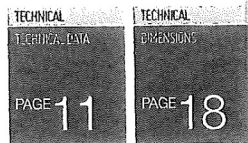
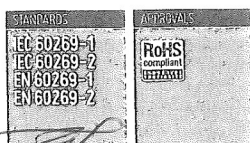

ВЯРНО С ОРИГИНАЛА



CYLINDRICAL FUSE HOLDERS



PMP PANEL MOUNTING FUSE HOLDERS **NEW**

www.df-sa.es/cylindrical/fuseholders/PMP/

10x38

REFERENCE	DESCRIPTION	I _n (A)	U (V)	PACKING Unit / BOX
486001	BAYONET FIXING	30	600	10/100
486002	SCREW FIXING	30	600	10/100

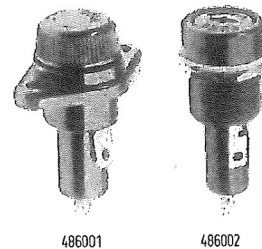

486001

486002

PMB PLUG CONNECTION FUSE HOLDERS **NEW**

www.df-sa.es/cylindrical/fuseholders/PMB/

10x38

REFERENCE	I _n (A)	U (V)	PACKING Unit / BOX
490030	32	500	20/100

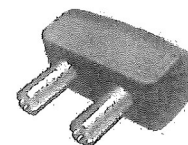

CLIP CONTACT FOR Ø10 FUSE-LINKS **NEW**

Clip contact for Ø10 cylindrical fuse links. Screw fixation and PCB versions. Manufactured in tinned bronze. All the materials are according to the European Directive 2002/95/EC RoHS (Restriction of the use of certain hazardous substances in electrical material).

10x38
10x85

REFERENCE	DESCRIPTION	I _n (A)	P _d max (W)	PACKING Unit / BOX
482001	Ø10 CLIP CONTACT SCREW FIXATION	25	4	50/200
482002	Ø10 CLIP CONTACT FOR PCB	25	4	50/200



482001



482002

ВЯРНО С ОРИГИНАЛА

STANDARDS	APPROVALS
IEC 60269-1 IEC 60269-2 EN 60269-1 EN 60269-2	RoHS compliant

TECHNICAL	TECHNICAL	TECHNICAL
TECHNICAL DATA	Ø10 FUSE HOLDERS DIMENSIONS	PHYS. DIMENSIONS & ADDRESSABLE DIMENSIONS
PAGE 11	PAGE 19	PAGE 21



469

CYLINDRICAL FUSE HOLDERS



CYLINDRICAL MODULAR FUSE HOLDERS

	PMF 8x32	PMF 10x38	PMX 8x32	PMX 10x38	PMX 14x51	PMX 22x38	PMX CC	PMX 8x32	PMX 10x38	BAC 14x51	BAC 10x38	BAC 22x38	PMP 10x38
RATED CURRENT	25 A	32 A	25 A	32 A	50 A	100 A	30 A	25 A	32 A	50 A	32 A	100 A	30 A
RATED VOLTAGE	400 V	690 V	400 V	690 V AC 750 V DC	690 V	690 V	600 V	400 V	690 V	690 V	690 V	690 V	600 V
RATED POWER DISSIPATION	2.5 W	3 W	2.5 W	3 W	5 W	9.5 W	3 W	3 W	3 W	12 W	8 W	20 W	
UTILIZATION CATEGORY	AC-22B 400V	AC-22B 500V AC-21B 690V	AC-22B 400V	AC-22B 500V DC-20B 750V DC	AC-21B 690V	AC-21B 690V	-	AC-20	AC-20	AC-20	IP-00	IP-00	IP-00
PROTECTION DEGREE	IP-20	IP-20	IP-20	IP-20	IP-20	IP-20	IP-20	IP-20	IP-20	IP-00	IP-00	IP-00	IP-00
OPERATING TEMPERATURE	-20...70 °C	-20...70 °C	-20...70 °C	-20...70 °C	-20...70 °C	-20...70 °C	-20...70 °C	-20...70 °C	-20...70 °C	-20...60 °C	-20...60 °C	-20...60 °C	-20...70 °C
STORAGE TEMPERATURE	-40...80 °C	-40...80 °C	-40...80 °C	-40...80 °C	-40...80 °C	-40...80 °C	-40...80 °C	-40...80 °C	-40...80 °C	-40...80 °C	-40...80 °C	-40...80 °C	-40...80 °C
OPERATING TEMPERATURE	20 °C	1	0.95	0.95	0.95	0.95	0.95	0.95	0.95	0.95	0.95	0.95	0.95
OPERATING TEMPERATURE	30 °C	0.95	0.9	0.9	0.9	0.9	0.9	0.9	0.9	0.9	0.9	0.9	0.9
OPERATING TEMPERATURE	40 °C	0.9	0.8	0.8	0.8	0.8	0.8	0.8	0.8	0.8	0.8	0.8	0.8
OPERATING TEMPERATURE	50 °C	0.8	1	1	1	1	1	1	1	1	1	1	1
OPERATING TEMPERATURE	1...4	1	0.8	0.8	0.8	0.8	0.8	0.8	0.8	0.8	0.8	0.8	0.8
OPERATING TEMPERATURE	5...6	0.7	0.7	0.7	0.7	0.7	0.7	0.7	0.7	0.7	0.7	0.7	0.7
OPERATING TEMPERATURE	7...9	0.6	0.6	0.6	0.6	0.6	0.6	0.6	0.6	0.6	0.6	0.6	0.6
OPERATING TEMPERATURE	≥ 10	0.6	0.6	0.6	0.6	0.6	0.6	0.6	0.6	0.6	0.6	0.6	0.6
FIXING	RAIL DIN / EN	SCREW	0.75...16 mm ² STRANDED	0.75...16 mm ² STRANDED	1.5...25 mm ² STRANDED	1.5...35 mm ² STRANDED	0.75...16 mm ² STRANDED	0.75...16 mm ² STRANDED	0.75...16 mm ² STRANDED	0.75...16 mm ² STRANDED	Ø 4 mm TERMINAL	4...70 mm ² STRANDED	2.5...35 mm ² STRANDED
CONNECTING WIRE	0.75...16 mm ² STRANDED	0.75...25 mm ² SOLID	0.75...16 mm ² STRANDED	0.75...16 mm ² STRANDED	1.5...35 mm ² STRANDED	1.5...50 mm ² STRANDED	0.75...16 mm ² STRANDED	0.75...16 mm ² STRANDED	0.75...10 mm ² STRANDED	4...25 mm ² SOLID	6...95 mm ² SOLID	4...70 mm ² STRANDED	4...70 mm ² STRANDED
WITH LIGHTNING INDICATOR	120...400V AC	120...690V AC	120...400V AC	120...690V AC	230...690V AC	230...690V AC	120...690V AC	120...690V AC	120...690V AC	120...690V AC	12...24V DC	12...24V DC	12...24V DC
MAX. TIGHTENING TORQUE	2.5 Nm (1P-N 1H)	2.5 Nm	2.5 Nm	2.5 Nm	3 Nm	4 Nm	2.5 Nm	2 Nm	2 Nm	2.5 Nm	2.5 Nm	2.5 Nm	3.5 Nm
WITH MICROSWITCH SA-250V	2.5 Nm (1P-N 1H)	2.5 Nm	2.5 Nm	2.5 Nm	3 Nm	4 Nm	2.5 Nm	2 Nm	2 Nm	2.5 Nm	2.5 Nm	2.5 Nm	3.5 Nm
MULTIPOLAR UNION WITH ACCESSORIES	2.5 Nm (1P-N 1H)	2.5 Nm	2.5 Nm	2.5 Nm	3 Nm	4 Nm	2.5 Nm	2 Nm	2 Nm	2.5 Nm	2.5 Nm	2.5 Nm	3.5 Nm
LABEL HOLDER	2.5 Nm (1P-N 1H)	2.5 Nm	2.5 Nm	2.5 Nm	3 Nm	4 Nm	2.5 Nm	2 Nm	2 Nm	2.5 Nm	2.5 Nm	2.5 Nm	3.5 Nm
LOCKING ACCESSORIES	2.5 Nm (1P-N 1H)	2.5 Nm	2.5 Nm	2.5 Nm	3 Nm	4 Nm	2.5 Nm	2 Nm	2 Nm	2.5 Nm	2.5 Nm	2.5 Nm	3.5 Nm



ВЯРНО СОПРИКА
 ЗАЩИТНО-СИГНАЛИЗИРАЩИ
 МОДУЛНИ ПИСТИЛИ
 ЗА ЗАЩИТА НА СИСТЕМИТЕ
 С НАПОН 250V