

Gas-Insulated Switchgear from 72.5 to 800 kV

Our complete range of products

Answers for energy.



SIEMENS 88



Handwritten signature

It's efficiency that counts – types 8DN8, 8DN9, 8DQ1 and 8DR1

Handwritten signature

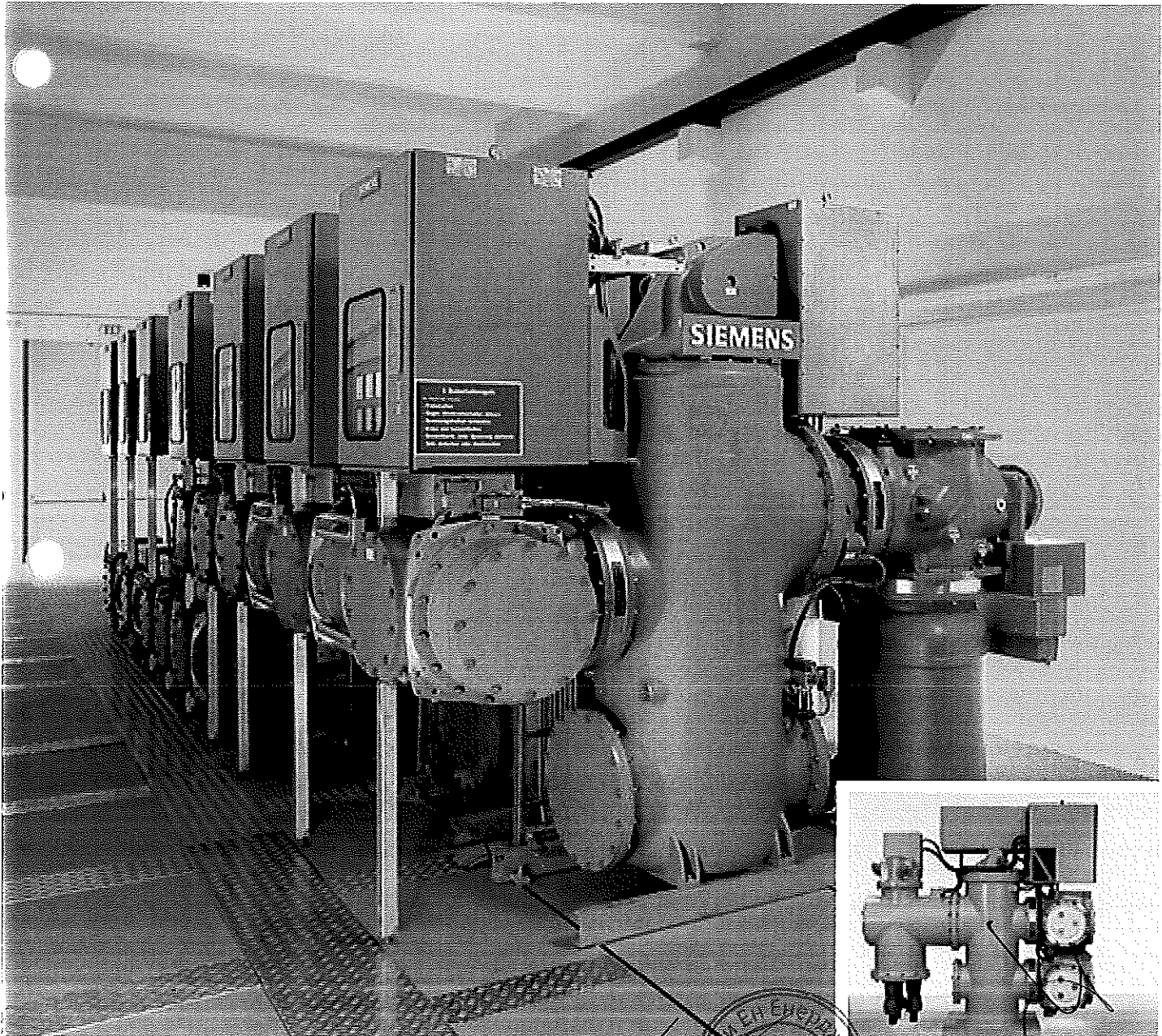

With a bay width of only 0.8 m, our 8DN8 is the most compact switchgear in the world for a rated voltage up to 145 kV.

ВАРНА
ОРИГИНАЛ

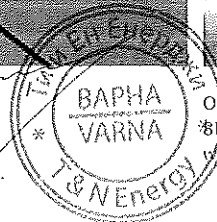

Our smallest switchgear is the 8DN8 for 72.5 kV with a bay width of only 650 mm.

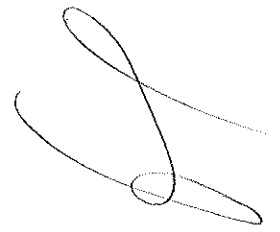

Efficiency, safety, and reliability are the factors that characterize our various gas-insulated switchgear types in the rated voltage range from 72.5 to 800 kV. The high standard of our products and services results from the comprehensive experience we have been able to gain from installing more than 17,000 switchgear bays in over 2,000 gas-insulated high-voltage substations and from more than 230,000 bay-operating years.

The type designations of our switchgear: 8DN8, 8DN9, 8DQ1, and 8DR1.

The latest results from research and production procedures are constantly being incorporated into development and manufacture to produce the very latest state of the art. This is what makes these four GIS types so efficient, effective, and economical.

Low investment costs

Our 8DN8 and 8DN9 switchgear are the most compact in the world. Our 8DN8, for example, takes up only 50% of the space comparable gas-insulated switchgear requires for a rated voltage up to 145 kV. This is achieved by a bay width of only 0.8 m and a bay-integrated control cubicle. The compact bay design and the aluminum enclosures result in low weight of the switchgear and, therefore, reduced load on foundations and building floors. For outdoor installation, the highly integrated switchgear series is a space-saving alternative.

Reliable, practically maintenance-free operation

Thanks to their high levels of performance and quality, our switchgear types are practically maintenance-free. The corrosion-free enclosures and the self-lubricating motor drives ensure a long service life. The main contacts of circuit breakers, disconnectors, and earthing switches are designed for long service life. The first inspection is due after 25 years.

Short delivery and installation times

Our computer-aided engineering tools and flexible logistics enable us to erect turnkey substations within a very short period. For example, the shipment of 8DN8 and 8DN9 bays as fully preassembled and factory-tested units makes for uncomplicated and rapid installation.

Tailored solutions

With few basic modules, we can configure any circuit variant you desire. This enables us to offer solutions tailored to existing buildings. We can also provide you with a control and protection system to suit your own particular needs – from conventional control to process-bus-capable digital bay-control systems – whether with conventional transducer or modern current and voltage sensors.

Your benefits:

- low investment costs due to low space requirements and short delivery and installation times
- low operating costs due to low maintenance, high availability, and reliability and a lifetime of more than 50 years.

Outdoor GIS 8DN8 (HIS switchgear, 5-circuit-breaker H-arrangement).

The transport units of our switchgear are fully preassembled and tested at the factory.

With the help of our computer-aided engineering tools, we can configure turnkey substations within a very short period.

Our highly integrated switching station requires minimal space even as an outdoor installation.

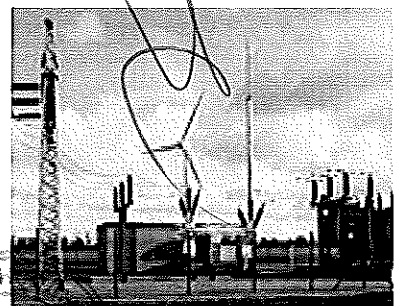
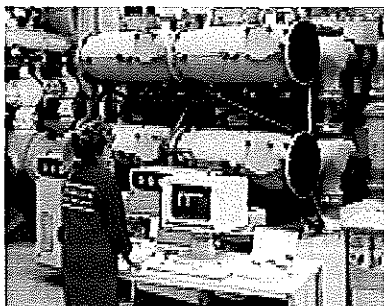

ВЯРНО С
ОРИГИНАЛА

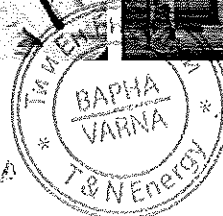



Safety combined with reliability and high availability



Even under the most extreme conditions, you can rely on our equipment.

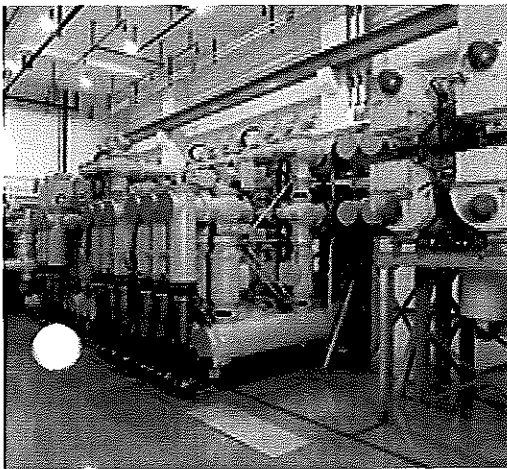

Due to its compact design and low levels of operating noise ...



... our gas-insulated switchgear is particularly well suited for use in urban areas.

At power supply utilities, in industry, at municipal facilities, in hospitals, or in extensive residential areas with their own power supply system – wherever you are, great demands are made on substations in terms of safety and reliability. Our 8DN9 switchgear with its rated voltage of up to 245 kV encompasses all the advantages of metal-clad design.

Highly reliable

The electromagnetic compatibility of the switchgear design, both externally and internally, prevents interference voltages and overvoltages. Our proven sealing system limits gas leakage to less than 0.5% per gas compartment per year.

Safety for the operating personnel

Our enclosures feature an extraordinarily high degree of mechanical stability and resistance to arcing. Modern calculation systems and tests have proven that the IEC safety standards are more than fulfilled. In the case of an impermissible rise in pressure, bursting discs in each gas compartment ensure an efficient pressure relief. Diverters lead the escaping gas off to harmless directions.

Your benefits:

- high safety of operation and high availability due to low gas leakage
- safety for your operating personnel due to high safety standards of the switchgear.

ВЯРНО С
ОРИГИНАЛА

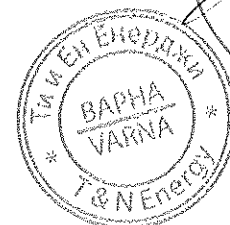

[Handwritten signature]

[Handwritten signature]

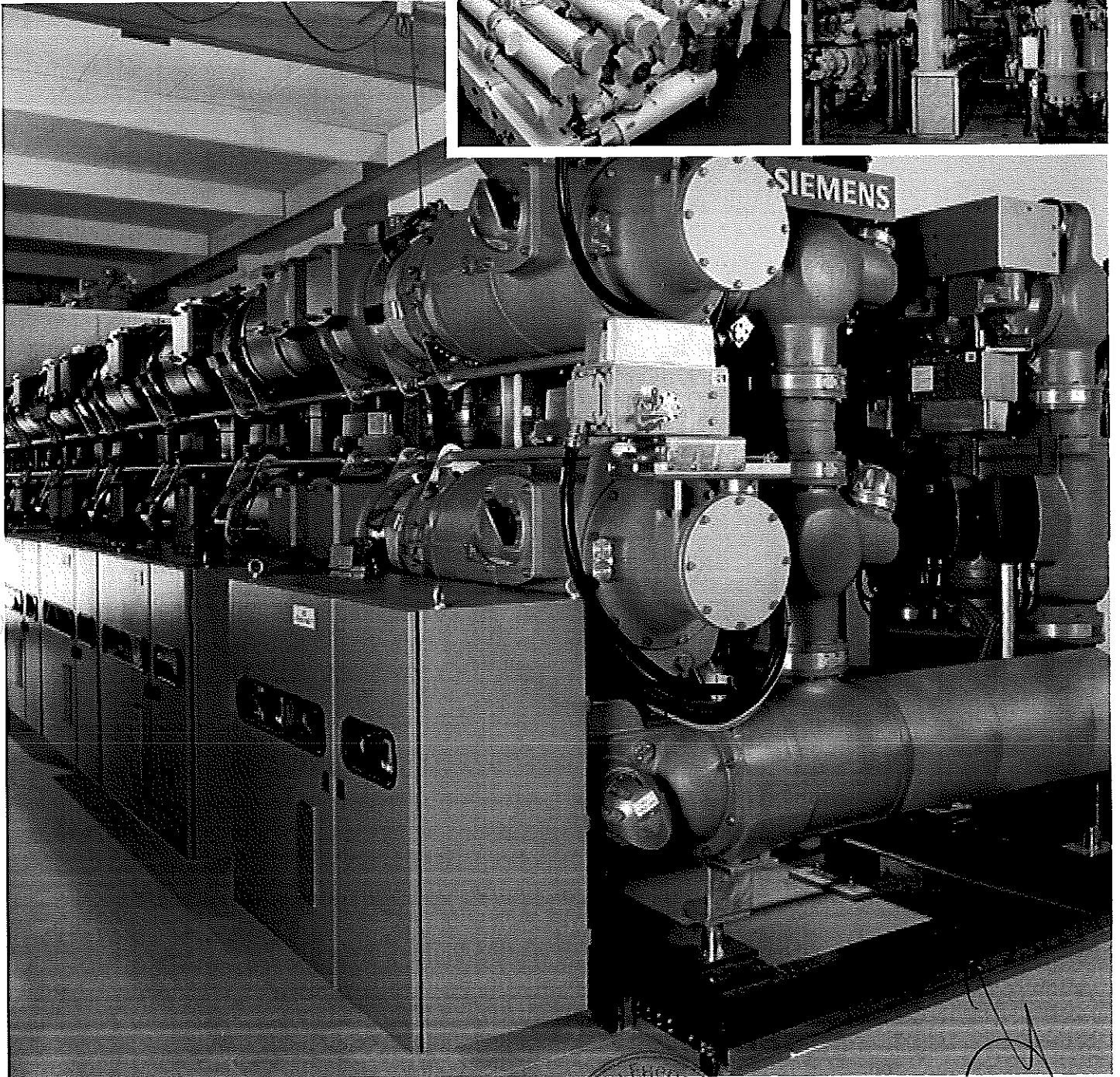
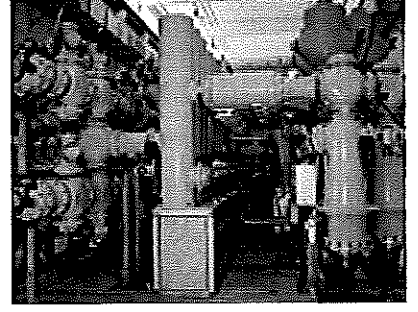
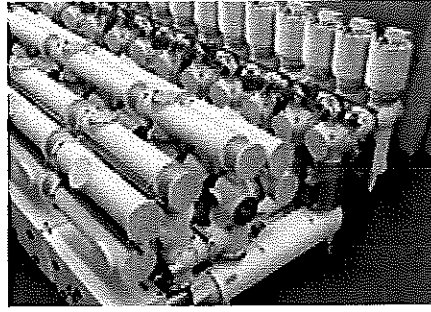

**ВЯРНО С
ОРИГИНАЛА**



Safety for personnel and the environment and
Availability of switchgear - this is what our 8DN9
switchgear is for

Support – attractive through our proximity to the customer

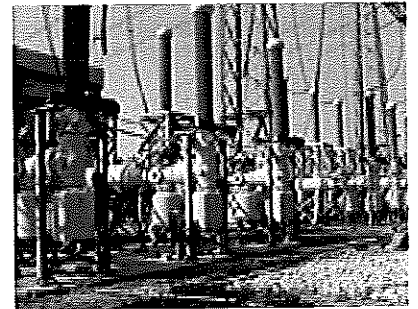
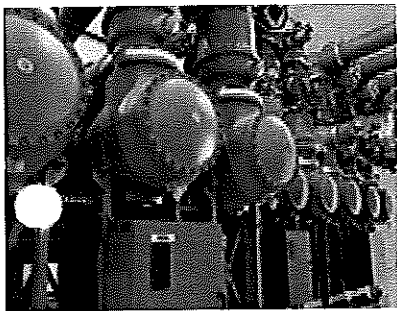

Our highly integrated 8DQ1 switchgear – the almost maintenance-free solution for outdoor use.



We build turnkey substations – the way you want them to be.

Cooperation right from the beginning: this is what we consider to be “attractive support” for our customers. From the initial idea, progressing through the phase of implementation and ending with comprehensive after-sales service – we are at your disposal: 24 hours a day and always close at hand. We offer this complete and comprehensive range of services for all our switchgear types – including the 8DQ1 with a rated voltage of up to 550 kV.

Individual and just as required

We provide you with constant project-related consulting and support right from the first moment you contact us, throughout the power system planning phase and up to putting your switchgear into service. We will assemble your switchgear just the way you want it; and all you will have to do is to turn the key. We will also train your personnel to a correspondingly high standard to make them become familiar with the ins and outs of your switchgear and competent in its use. And you don't even have to worry about maintenance work. Our gas-insulated switchgear does indeed require very little maintenance, but if and when it should become necessary to carry out any work, we are on hand at all times. We can also come to your aid when you want to dispose off your old switchgear.



We are always at your disposal – not only throughout all phases of planning and implementation, but also during the operation of your switchgear.



Your benefit:

An attractive, competent partnership with Siemens.

ВЯРНО С
ОРИГИНАЛЪТ

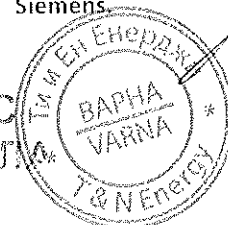

Technical data at a glance

ВЯРНО С
ОРИГИНАЛА

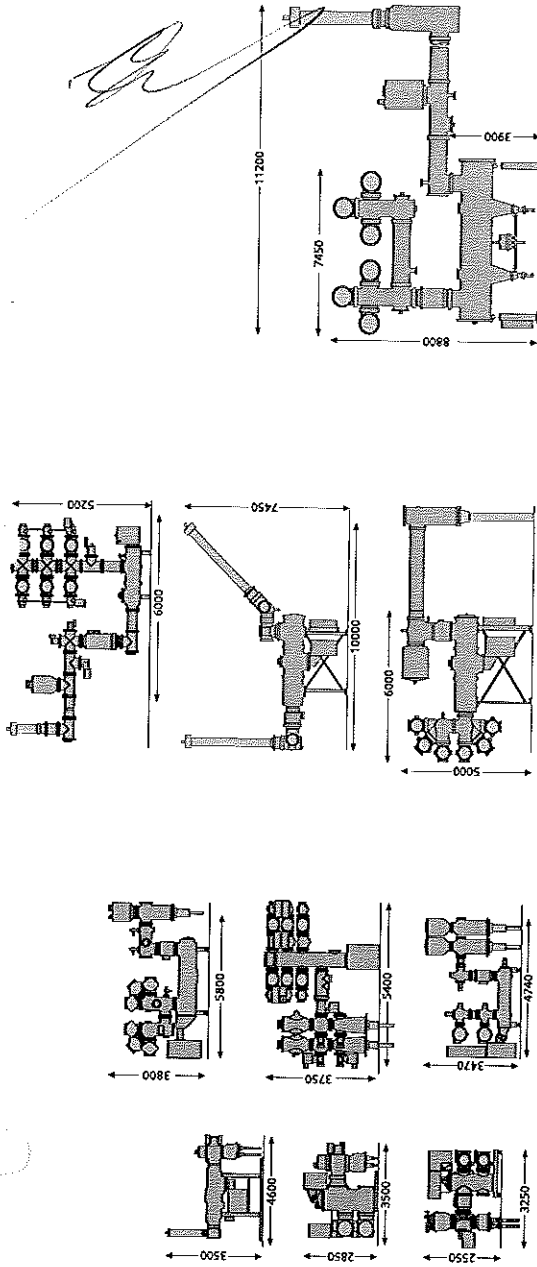

Switchgear type	8DN8	8DN9	8DR1	8DR1
Rated voltage	kV 72.5/114.5	24.5/30.0	420/550	800
Rated power-frequency withstand voltage (1 min)	kV 140/275	460	650/740	950
Rated lightning impulse withstand voltage (1.2/50 μs)	kV 325/650	1050	1425/1550	2100
Rated switching impulse withstand voltage (250/2500 μs)	kV -	850	1050/1250	1550
Rated normal current busbar	A 2500/3150	3150/4000	5000/6300	8000
Rated normal current feeder	A 2500/3150	3150/4000	5000	5000
Rated short circuit-breaking current	kA up to 31.5/40	50/63	50/63	63
Rated peak withstand current	kA up to 85/108	135/170	135/170	170
Rated short-time withstand current	kA up to 31.5/40	50/63	50/63	63
Leakage rate per year and gas compartment	% ≤ 0.5	≤ 0.5	≤ 0.5	≤ 0.5
Driving mechanism of circuit breaker	stored-energy spring	stored-energy spring	stored-energy spring	hydraulic
Operating sequence	O-0.3 s-CO.3 min-CO CO-1.5 s-CO	O-0.3 s-CO.3 min-CO CO-1.5 s-CO	O-0.3 s-CO.3 min-CO CO-1.5 s-CO	O-0.3 s-CO.3 min-CO CO-1.5 s-CO
Rated supply voltage	V DC 48 to 250	48 to 250	60 to 250	60 to 250
Ambient temperature range	°C -30 to +40	-30 to +40	-30 to +40	-25 to +40
Standards	IEC/IEEE	IEC/IEEE	IEC/IEEE	IEC/IEEE
Bay width	mm 650/800/1200	1500/2200	2550/3600	4500
Inspection	Years > 25	> 25	> 25	> 25
Expected lifetime	Years > 50	> 50	> 50	> 50

Other data on request

[Handwritten signature]

[Handwritten signature]

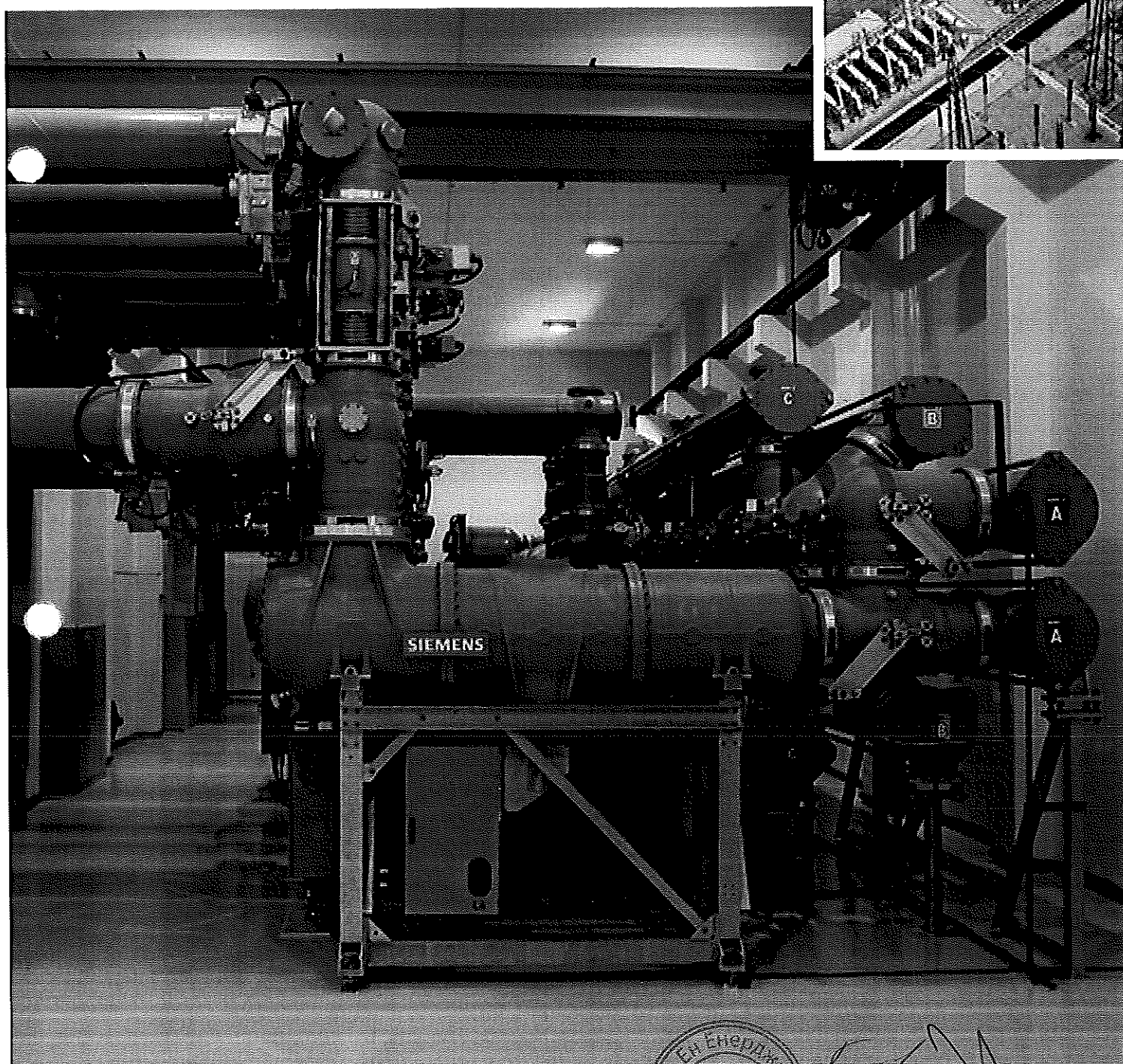

ВЯРНО С
ОРИГИНАЛА

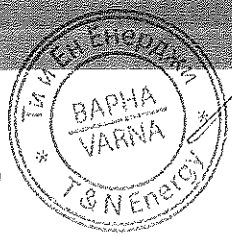

[Handwritten signature]

For further information

Phone +49 91 31/7-3 46 60
Fax +49 91 31/7-3 46 62
E-mail: h-gis.ptd@siemens.com
www.hv-substations.com

Name/Company

Street

City (incl. postal code/country)

Telephone/Fax

E-mail

Please send me more information on the following topics:

- HIS CD-ROM
- HIS – Highly Integrated Switchgear up to 145 kV
- Gas-insulated switchgear up to 145 kV
- Gas-insulated switchgear up to 245 kV
- HIS – Highly Integrated Switchgear up to 550 kV
- Gas-insulated switchgear up to 550 kV
- Container-type substations
- further copies of this brochure

Published by and copyright © 2008
Siemens AG
Energy Sector
Postfach 32 20
91050 Erlangen, Germany

www.siemens.com/energy

If you would like more information
please get in touch with your
Siemens contact or our Customer
Support Center.
Phone: +49 180/524 70 00
Fax: +49 180/524 24 71
(Charges depending on provider)
E-mail: support.energy@siemens.com
www.siemens.com/energy-support

Power Transmission Division
Order No. E50001-G620-A101-V6-4A00
Printed in Germany
Dispo 30000
fb 1343 61/14456 103327 WS 07082.0

All rights reserved. Trademarks or product names used in this document are the property of Siemens AG or its associated companies or the particular owners in each case.
Subject to change without prior notice. The information in this document contains general descriptions of the technical options available, which do not always have to be present in individual cases. The required features should therefore be specified in each individual case at the time of closing the contract.
Printed on elementary chlorine-free paper.



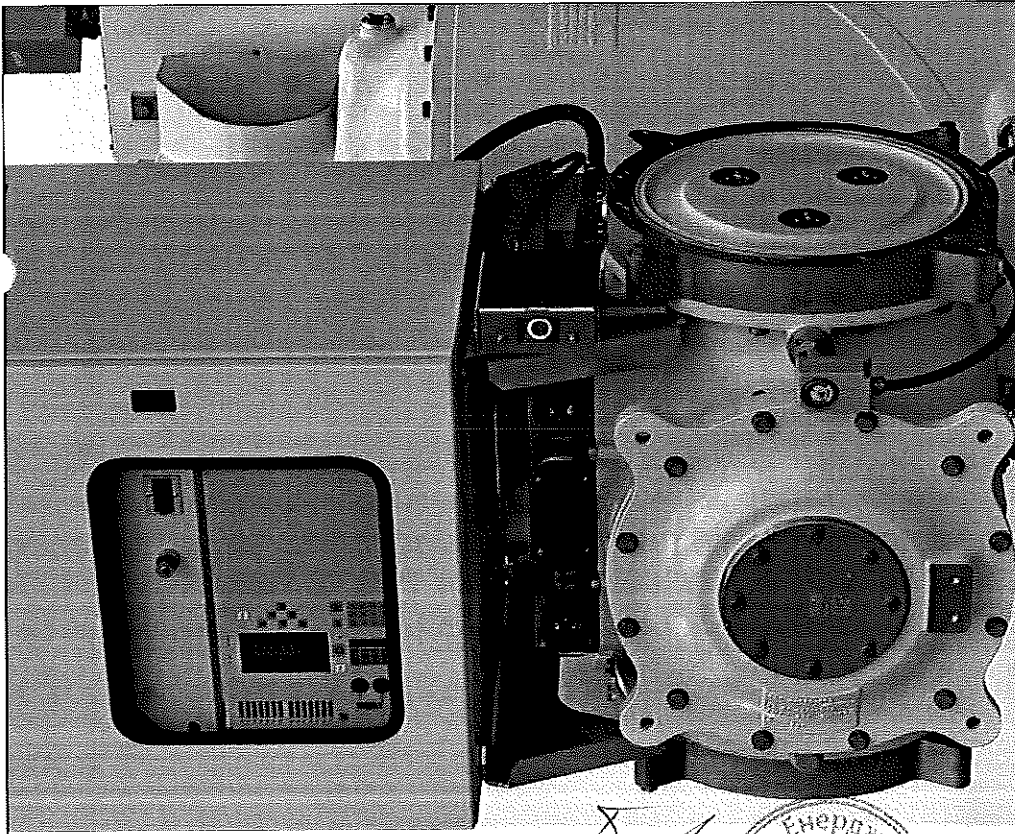

Gas-insulated switchgear
up to 145 kV, 40 kA, 3150 A
type series 8DN8

Answers for energy.

SIEMENS

ВЯРНО С
ОРИГИНАЛА

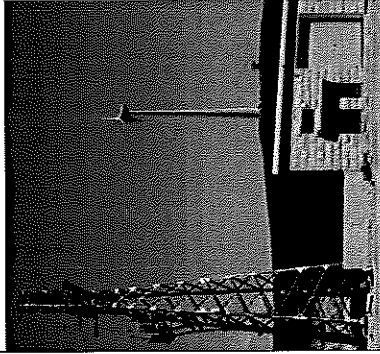

Connecting environment-friendly wind energy to the grid with compact 8DN8 GIS in switchgear building



Bay control systems in ergonomically arranged local control cabinet

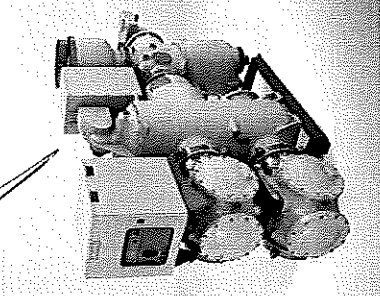

8DN8 switchgear up to 145 kV, outgoing cable bay

Benefiting from experience

Our 8D series of gas-insulated switchgear represents a highly successful product concept.

Since its introduction in 1968, Siemens has installed more than 24,000 bays worldwide. A total of well over 285,000 years of bay operation have since been recorded.

Intensive research work, many years of system experience, and continuous further development of the first system types have ultimately led to today's generation of gas-insulated, metal-enclosed switchgear – a world leader when it comes to

- economic efficiency
- high reliability
- long service life
- safe encapsulation
- very high degree of gas-tightness
- low life cycle and maintenance costs
- easy access and ergonomic design
- high availability
- reliable operation even under extreme environmental conditions

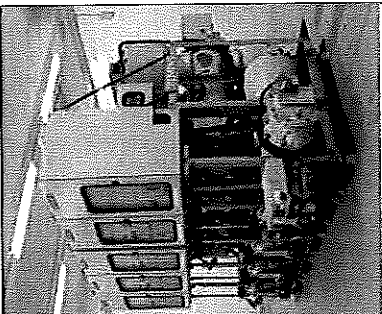

8DN8 switchgear for 72.5 kV single busbar arrangement

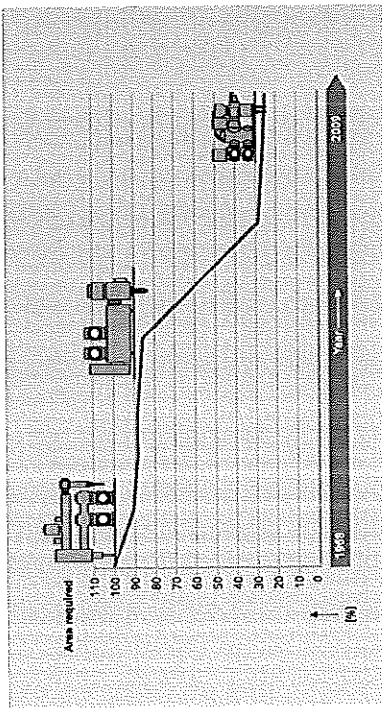

Continuous further development has reduced the footprint required for 145-kV GIS to only 25% of the first designs in 1968

Our type series 8DN8 switchgear for all voltage levels from 72.5 kV to 145 kV represents one of the most compact systems of its kind available worldwide, and meets all of today's requirements for modern, pioneering switchgear in terms of efficiency and economy, its space-saving design and its low weight help make this switchgear extremely economical.

Since the levels of noise and field emission (EMC) are extremely low, it is possible to easily integrate 8DN8 switchgear even in sensitive environments, residential quarters, and city centers. They feature high energy efficiency over the entire process chain – from production and commissioning to recycling – and meet all current requirements for environmentally compatible high-voltage switchgear.

- Switchgear type series 8DN8 145 kV combines technical expertise with all standards and advantages of the Siemens 8D type series. It also offers a number of distinct advantages:
- Rapid availability thanks to time-saving delivery and installation concepts
- Independence from atmospheric and external influences
- Suitability for indoor and outdoor installation
- Convincingly space-saving system configurations (e.g. H configuration, 1/2 breaker, ring, etc.)
- High flexibility of switchgear arrangement for optimized system management
- Adaptable to all predecessor models of the same voltage level

Switchgear type series 8DN8 72.5 kV corresponds to switchgear 8DN8 145 kV with regard to construction and technical design but it is significantly smaller. The extremely small component dimensions allow it to be deployed wherever space is at a premium.

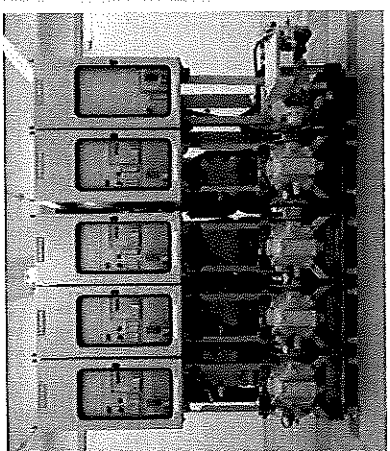

The 8DN8 allows a high degree of versatility in switchgear layout thanks to its modular construction

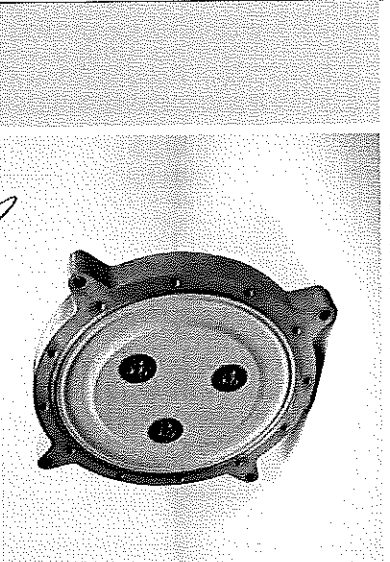

The innovative design of the cast resin bushings allows maximum flexibility in the design of bays and for installation and service work

Flexible due to modular design

A fundamental feature of our gas-insulated switchgear is the high degree of versatility made possible by its modular system. Depending on their respective functions, the components are housed either individually and/or combined in pressure-resistant, gas-tight enclosures. With a remarkably small number of active and passive modules, all customary bus schemes are possible. Standard adapters ensure compatibility with all predecessor models of the same voltage level.

Three-phase enclosures are used for type series 8DN8 switchgear in order to achieve extremely low component dimensions. This concept allows a very compact design with minimum space requirement. The ergonomic modular principle makes for easy access to control elements.

Aluminum is used for the enclosure. This guarantees freedom from corrosion and ensures lightweight equipment. The use of modern construction methods and casting techniques makes it possible to optimize the enclosure's dielectric and mechanical characteristics. The low bay weight ensures minimal floor loading and eliminates the need for complex foundations.

All the modules are connected to one another by means of flanges. The gas-tightness of the flange connections is assured by O-ring seals that have been proven in operation since 1968.

Temperature-related changes in the length of conductors are compensated by coupling contacts. Where necessary, the joints are accessible via openings sealed with gas-tight covers. Sulfur hexafluoride (SF₆) is used as the insulating and arc-quenching medium. It is contained in an extremely gas-tight enclosure so that it cannot pollute the environment.

Gas-tight bushings allow subdivision of the bay into a number of separate gas compartments, each of which is provided with its own gas monitoring equipment. The static filters in the gas compartments absorb moisture and decomposition products. The use of rupture diaphragms reliably prevents shattering of the enclosure in the case of buildup of abnormally high pressure. Diverter nozzles on the rupture diaphragms ensure that the gas is expelled in a defined direction in the event of bursting, thus ensuring that the operating personnel are not endangered.

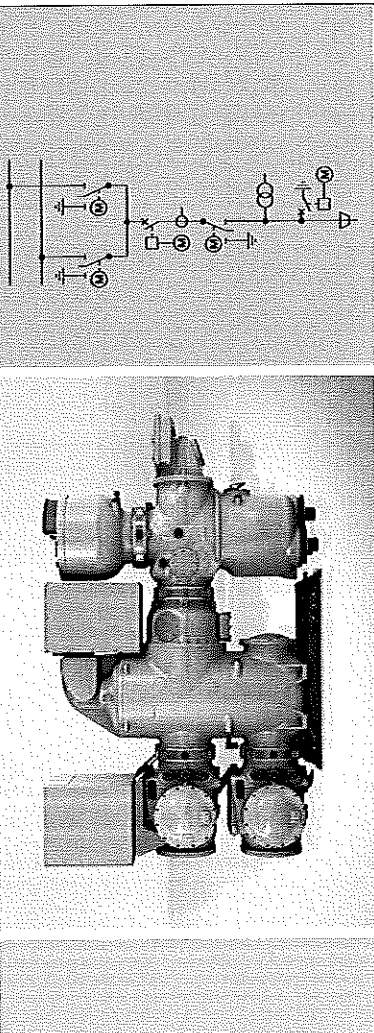

Three-phase enclosure allows compact design:
8ND8 145 kV, cable bay with double busbar

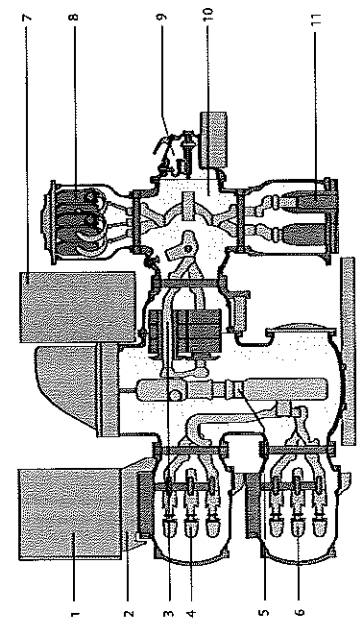

1. Integrated local control cubicle
2. Support for control cubicle
3. Current transformer
4. Busbar II with disconnect and earthing switch
5. Interrupter unit of the circuit-breaker
6. Busbar I with disconnect and earthing switch
7. Stored-energy spring mechanism with circuit-breaker control unit
8. Voltage transformer
9. High-speed earthing switch
10. Outgoing feeder module with disconnect and earthing switch
11. Cable sealing end

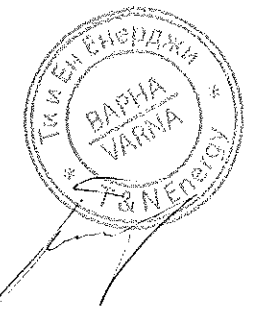

ВЯРНО С
ОРИГИНАЛА

Circuit-breaker module

The central element of the gas-insulated switchgear is the three-pole encapsulated circuit breaker comprising the following two main components:

- interrupter unit
- operating mechanism

The design of the interrupter unit and of the stored-energy spring mechanism is based on proven and in most cases identical designs which have often been used for outdoor switchgear installations worldwide.

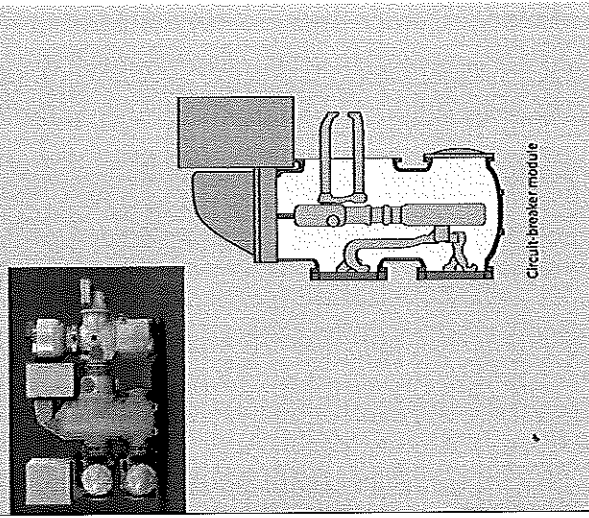

Circuit-breaker module

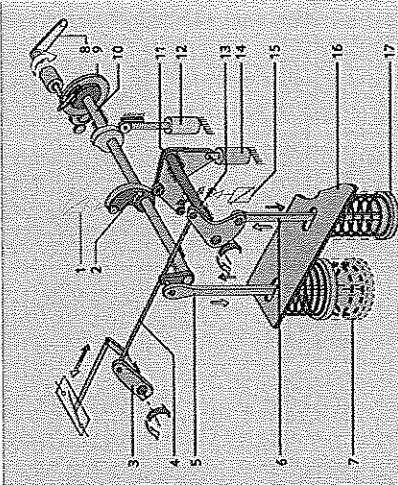

1. Trip coil CLOSE
2. Cam plate
3. Corner gears
4. Connecting rod
5. Connecting rod for closing Spring
6. Connecting rod for opening spring
7. Closing spring
8. Emergency hand crank
9. Charging gear
10. Charging shaft
11. Roller lever
12. Damper (for closing)
13. Operating shaft
14. Damper (for opening)
15. Trip coil OPEN
16. Drive mechanism housing
17. Opening spring

Operating mechanism

The stored-energy spring mechanism provides the force for opening and closing the circuit-breaker. It is installed in a compact corrosion-free aluminum housing. The closing spring and the opening spring are arranged in order to ensure good visibility within the drive unit. The entire drive unit is completely isolated from the SF₆ gas compartments. Roller bearings and a maintenance-free spring mechanism ensure decades of reliable operation.

Proven design principles of Siemens circuit-breakers are used, such as vibration-isolated latches and load-free isolation of the charging mechanism. The operating mechanism offers the following advantages:

- defined switching position which is securely maintained even if the auxiliary power supply fails
 - tripping is possible irrespective of the status of the closing spring
 - high number of mechanical operations
 - low number of mechanical parts
 - compact design
 - choice of single-pole or common drive design.
- The single-pole version allows single-pole automatic reclosing.

Interrupter unit

The interrupter unit used in the circuit-breaker for arc quenching operates on the proven self-compression principle. Since this requires only minimal operating energy the mechanical stresses involved are low. Stressing of both the circuit-breaker and the housing is reduced.

The current path

In the case of a self-compression circuit-breaker, the current path is formed by the contact support (1), the base (6), and the moving contact cylinder (5). In the closed position, the operating current flows through the contact finger (3) and the arcing contact (4) which is also closed.

Interruption of operating current

During the breaking operation, the contact finger (3) opens first and the current continues to flow via the arcing contact (4), which is still closed. This prevents erosion of the main contacts. As the breaking operation progresses, the arcing contacts (4) open and an arc develops between them. Simultaneously, the contact cylinder (5) moves into the compression volume (6) and compresses the remaining arc-quenching gas. The compressed arc-quenching gas flows through the contact cylinder (5) into the contact gap and extinguishes the arc.

Interruption of fault currents

If the short-circuit current is high, the arc-quenching gas at the arcing contact is heated considerably by the arc's energy. This leads to a strong, additional rise in the pressure in the contact cylinder and builds up the necessary arc-quenching energy. Consequently, this energy does not have to be supplied by the operating mechanism. As the switching operation progresses, the fixed arcing contact releases the outflow from the nozzle (2). The gas now flows out of the contact cylinder and through the nozzle, thus extinguishing the arc.

Arc-quenching principle

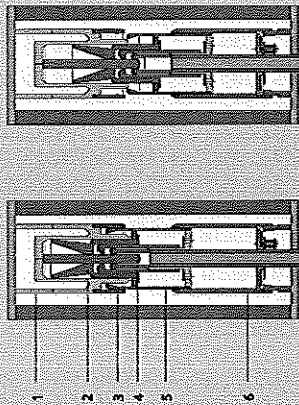

Breaker in "On" position

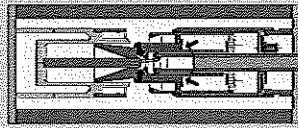

Breaking: arcing contact open

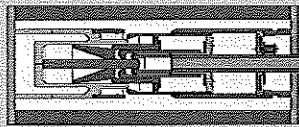

Breaking: main contact open

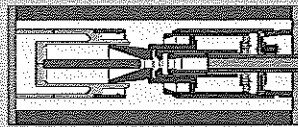

Breaker in "Off" position

1. Contact support
2. Nozzle
3. Contact finger
4. Arcing contact
5. Contact cylinder
6. Base

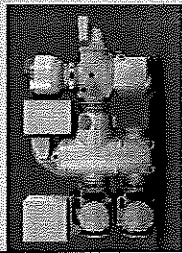

Schematic diagram



Neutral position



Disconnector closed



Earthing switch closed



Outgoing feeder module: downstream of the disconnecting switch



Outgoing feeder module: upstream of the disconnecting switch



Busbar module



Bus sectionalizer

Three-position switching device

The functions of a disconnecting switch and an earthing switch are combined in a three-position switching device.

The moving contact either closes the gap or connects the high-voltage conductor to the mating contact of the earthing switch. Integral mutual interlocking of the two functions is achieved as a result of this design, thus eliminating the need for providing corresponding electrical interlocking. An insulated connection to the mating contact of the earthing switch is provided outside the enclosure for test purposes. In the third, neutral position, neither the disconnecting contact nor the earthing switch contact is closed. The three poles of a bay are mutually coupled and all three poles are operated at once by a motor drive. Force is transmitted into the enclosure via gas-tight rotating shaft glands. The alarm switches and the on/off indicators are friction-locked and are connected directly to the drive shaft. Manual emergency operation is possible. The enclosure can be provided with generously sized view ports, through which the switching position of all three phases is visible.

The three-position switching device is contained in a number of different modules:

Outgoing feeder module

The outgoing feeder module connects the basic bay with various termination modules (for cable termination, overhead line termination, and transformer termination). It contains a three-position switching device, which combines the functions of an outgoing feeder disconnector and of a bay-side earthing switch (work-in-progress type). Installation of a high-speed earthing switch and of a voltage transformer is also possible where required. The high-voltage site testing equipment is generally connected to this module.

Busbar module

Connections between the bays are effected by means of busbars. The busbars of each bay are enclosed. Adjacent busbar modules are coupled by means of expansion joints. The module contains a three-position switching device, which combines the functions of a busbar disconnecting switch and of a bay-side earthing switch (work-in-progress type).

The busbar can also be of the passive type.

Bus sectionalizers

Bus sectionalizers are used for isolating the busbar sections of a substation. They are integrated in the busbar in the same manner as a busbar module. The module contains a three-position switching device which combines the functions of a bus sectionalizer and of an earthing switch (work-in-progress type).

ВЪПРОС
ОПРЕДЕЛЕНИЕ



High-speed earthing switch

The high-speed earthing switch used is of the so-called "pin-type." In this type of switch, the earthing pin at earth potential is pushed into the tulip-shaped mating contact. The earthing switch is equipped with a spring-operated mechanism, charged by an electric motor.



High-speed earthing switch

Instrument transformers

Current and voltage transformers are used for measuring, protection, and monitoring purposes and can be integrated at any point within the substation. The secondary connections are led out of the enclosure through gas-tight bushings and brought into contact with terminals. They are supplied in a number of variants – ranging from conventional instrument transformers of different classes and standards to advanced current and voltage sensors.

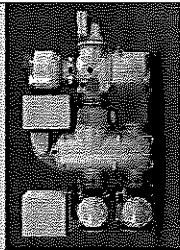

Short current transformer



Long current transformer

Current transformer

As a general rule, conventional induction type current transformers are used which are individually matched to the different requirements of measurement and protection systems. The high-voltage conductor forms the primary winding. The individual cores with the secondary windings constitute independent measurement circuits. Changeover to a different transformation ratio is possible by means of secondary-side tap connections. The current transformer should preferably be arranged in the bay directly downstream of the circuit-breaker.

Voltage transformer/voltage divider

Conventional induction type voltage transformers, which are individually matched to the different requirements of measurement and protection systems, are predominantly used. Voltage transformers should preferably be provided on the busbar and in the outgoing circuit. Optional insulating clearances at the primary terminal enable the transformer to be switched on and off in the high-voltage test.

Voltage transformers of the "Power VT" design provide a convenient interface for carrying out high-voltage tests effortlessly, not only during commissioning but also over the entire life cycle of a GIS system, for example after expansions.

RIC voltage dividers are designed to match advanced digital measurement and protection systems. They map high voltage in linear form over a wide frequency range and are therefore suitable, for example, for monitoring voltage quality, especially for networks in which semiconductor technologies are used to an increasing extent.

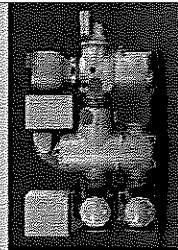

Conventional voltage transformer Power VT



AC voltage divider

Connection modules

Connection modules join system components within a bay. They are also used for pipework penetrations and form the connection between switchgear components situated far apart. They also provide a means of connecting equipment such as transformers or overhead lines located some distance away. Both single-pole and three-pole encapsulated connection modules are available depending on the circuit and the spatial layout of the bay.

Extension modules

Extension modules connect switchgear components that are a long way away from each other in a straight line.

T-modules

T-modules are used as branch-off points or for attaching a surge arrester, voltage transformer, earthing switch, or outgoing feeder module. Their basic design is always the same in every version.

Angular modules

Angular modules are used for splitting the conductors in outgoing leads. They are available in designs with angles of 30°, 45°, 60°, and 90°. With the three-pole 90° module it is also possible to implement offset system designs and long outgoing leads.

Splitting module, single-pole/three-pole

Splitting modules are used for connecting three-pole switchgear components to single-pole components. As a rule, they form the connection between the outgoing feeder module and various termination modules (for example, overhead line termination, transformer termination).

Surge arrester

If required, encapsulated surge arresters can be connected directly. They serve to limit overvoltages that may occur. Their active part consists of metal-oxide resistors with strongly non-linear current/voltage characteristics. The arrester is generally flange-jointed to the switchgear via a gas-tight bushing. The arrester housing incorporates an inspection hole, through which the internal conductor can be accessed for inspection purposes. There are connections for gas monitoring and arrester testing on the underside.

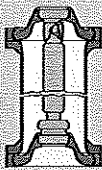

Single-pole extension module



Three-pole extension module



Design variants of T-modules



Three-pole 90° angular module



Design variants of single-pole angular modules



Splitting module

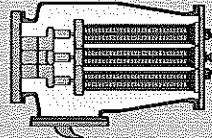

Surge arrester

Handwritten signature or mark at the top right of the page.

Termination modules

The termination modules connect the bays of the gas-insulated switchgear to the following items of equipment:

- overhead line
- transformer or reactor
- cable

They thus form the transition between the SF₆ gas insulation within the enclosure and other insulating media.

Cable termination

This three-pole module links the metal-enclosed gas-insulated switchgear with the high-voltage cables. All customary types of high-voltage cables can be connected without problem via conventional cable sealing ends or plug-in types. The primary conductor between the cable sealing end and the switchgear can be removed in the neighboring outgoing feeder module to perform a high-voltage withstand test.

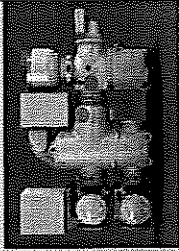

Example: cable termination (plug-in type)



Example: cable termination (conventional type)

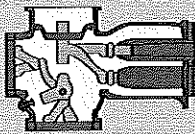

Example: cable termination (conventional type) with disconnecting switch

SF₆/air termination

The single-pole SF₆/air termination module forms the transition from the gas-insulated switchgear to air-insulated components or overhead lines. This termination is a combination of single-pole connection modules and an outdoor SF₆ bushing. Length, shed form, and creepage distance of the outdoor/SF₆ bushing are determined in line with insulation coordination, minimum clearance, and degree of pollution. The outdoor termination module is suitable for air-insulated connections between GIS and

- overhead lines
- outdoor bushings of outdoor transformers or reactors
- outdoor sealing ends of high-voltage cables.

The splitting of the connection points for the three phases with the necessary clearance in air for conductor insulation is taken into account in the design of the switchgear.

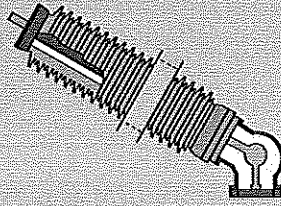

SF₆/air termination

Transformer tube-termination

Similar to the outdoor termination module, the single-pole transformer termination module is connected to the three-phase encapsulated basic bay via a combination of connection modules. It effects the transition from the GIS directly to the bushing of oil-insulated transformers or reactors. The transformer bushing must be oiltight and resistant to gas pressure. Temperature-related movements and non-uniform settling of the switchgear and transformer foundations are absorbed by expansion joints.

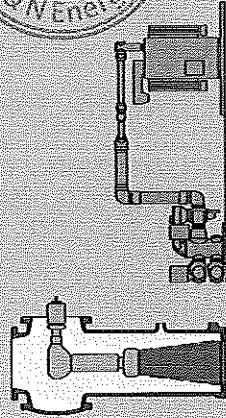

Transformer tube-termination

Variations are possible with switchgear type series 72.5.

Left: Stored-energy spring mechanism of the circuit-breaker
Right: Integrated local control cubicle with bay controller

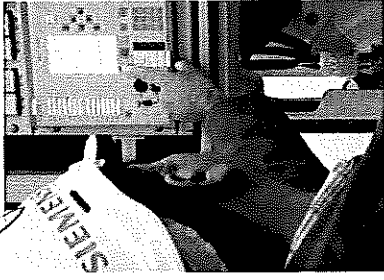
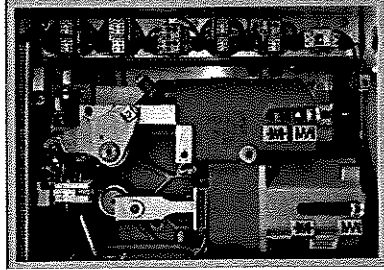

Control and monitoring – consistent and flexible control and protection

Proven switchgear control

All the elements for the auxiliary and control circuits are accommodated in a decentralized arrangement in the high-voltage switching devices. The complete drive mechanisms for the switchgear are factory-tested. Only tried and tested Siemens technology is used in the auxiliary and control circuits.

Switchgear is usually supplied complete with bay-internal cabling, for example all the way to the integrated local control cubicle. This minimizes the time required for installation and commissioning and reduces the possibilities of error.

Additional sensors and interfaces can be provided optionally for diagnostics systems or modules for permanent monitoring of the precise current data condition.

Gas monitoring

Each switchgear bay is divided into a number of gas compartments. These gas compartments are constantly monitored by means of density monitors with integrated indicators; any deviations are indicated as soon as they reach the defined response threshold. The optionally available density sensors allow remote indication and further processing of the current measured value for each gas compartment in digital control and protection systems.

Flexible and reliable control and protection system

Control and feeder protection are generally accommodated in the local control cubicle, which is itself integrated in the operating panel of the switchgear bay. This reduces the amount of space needed and the time required for commissioning. Alternatively, a version of the local control cubicle for installation separate from the switchgear is available as a flexible solution for meeting different requirements with respect to the arrangement of the control and protection components. The cabling between the local control cubicle and the high-voltage switching devices is effected via coded plugs, which minimizes both the installation cost and the risk of cabling errors.

Of course, type series 8DNS switchgear is available on request with any commonly available bay and substation control and protection systems as well as uniform systems to meet your individual requirements. Standard interfaces in the switchgear control allow interfacing of

- conventional control systems with protective interlocking and control panel
- digital control systems with user-friendly bay controllers and substation automation with PC-operator station (HMI)
- intelligent, fully networked digital control and protection systems with supplementary monitoring and remote diagnostic functions.

The wide range of Siemens control and protection systems enables us to provide customized concepts from a single source.

ВАРНА
ОРИЕНТАЦИЯ

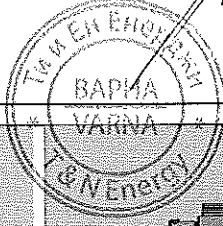

Left: high-voltage test on site with "Power-VT"
Right: 8DN8 switchgear offers maximum flexibility for all aspects of transport

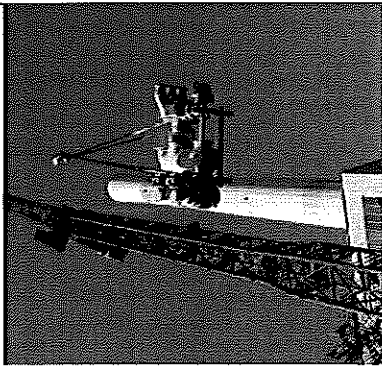
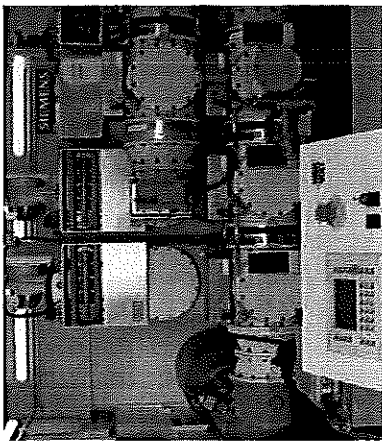

Transport, installation, commissioning, operation, and maintenance

Transport

The 8DN8 is optimized for transport and on-site installation. Thanks to the compact dimensions of the 8DN8 it can be shipped in standard containers and by road, and is transported in the largest possible units that are still easy to handle. It is thus possible to dispatch up to six single or three double switchgear bays, completely assembled and tested, as a single transport unit. In transport units containing switching devices, all operating mechanism attachments are preset at the factory prior to shipment. All flanges, where the modules are to be joined to other equipment, are protected against corrosion and sealed with transport covers. All items are packed according to the specific transport conditions. Special sealed packing is used for shipments to countries outside Europe, allowing transport overseas and combined transport and storage durations of 12 months or more.

Installation and assembly

The delivery of complete factory-assembled and tested single and double bays reduces the time and effort required for installation on-site. It only needs simple devices to move the transport unit to its installation position and align it for assembly with the other bays. A mounting frame facilitates movement and rapid alignment of the bays. Only few anchorings and hardly any additional steel supports are required for securing the switchgear to the foundation. Depending on the bay design, only the bay termination needs to be assembled. On the secondary side, only bay-to-bay cabling and interfacing to the substation control and protection system are required.

Siemens provides complete installation and commissioning on site. Uncomplicated work procedures, detailed installation instructions, and the use of relatively few special tools allow easy and rapid installation of the switchgear by your own personnel under the guidance of an experienced supervisor from Siemens. If required, your personnel can acquire the necessary know-how in a special training program.

Commissioning

After assembly, the entire switchgear undergoes final testing for gas-tightness. At the same time, all switching devices and all electrical circuits for control and monitoring are tested to ensure their proper function in both mechanical and electrical terms. All tests are performed in conformity with IEC and the results documented in reports.

Operation and maintenance

Our gas-insulated switchgear is designed and manufactured so as to achieve an optimal balance of design, materials used, and maintenance required. The hermetically sealed enclosures and automatic monitoring ensure that the assemblies are practically maintenance-free under normal operating conditions. We recommend that the first major inspection be carried out after 25 years.

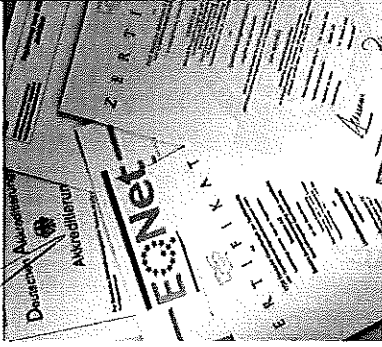

Quality assurance and environmental aspects

A consistent quality management system supported by our employees ensures the production of gas-insulated switchgear of the highest quality. The system was certified in 1983 in accordance with CSA Z299 and again in 1989 according to DIN EN ISO 9001. The quality management system is process-oriented and subject to continuous improvement. Naturally, the Siemens QM system has been successfully re-certified at regular intervals according to DIN EN ISO 9001. As early as 1994, a DIN EN ISO 14001-compliant environment management system was implemented as an addition to the existing management system and successfully certified. One of the major milestones in developing testing expertise was the certification of the test labs according to ISO/IEC 17025 (previously EN 45001) in 1992. From that point on, they have been considered independent. The quality and environment management systems cover every single process in our products' life cycles, from marketing to after-sales service.

The expert packing concept is optimized along ecological lines and provides for the switchgear's safe arrival at its destination. Design aspects also play a crucial role in the outstanding ecological balance of type series 8DN8 switchgear. The exceptionally compact construction results in low consumption of materials and energy in production, a relatively small requirement for SF₆, resource-saving transport options without wood packaging and finally lower space requirement for installation of the switchgear.

Regular management reviews and audits of all processes ensure that the system is effective and up-to-date at all times and that appropriate measures are taken to continuously improve it. The audits are based on the consistent documentation of all processes relevant to quality and the environment. The quality of our switchgear consequently meets even the highest requirements.

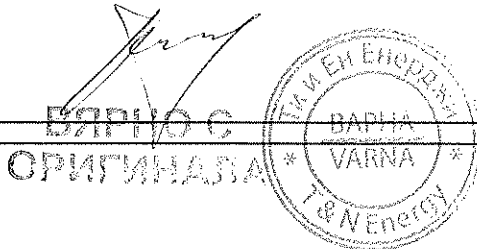

103

Typical bay arrangements

All the standard circuit configurations can be realized using our type series 82N8 switchgear.

Coupling bay

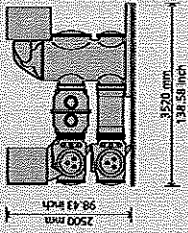

Cable bay

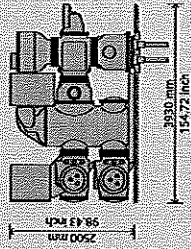

Overhead line bay

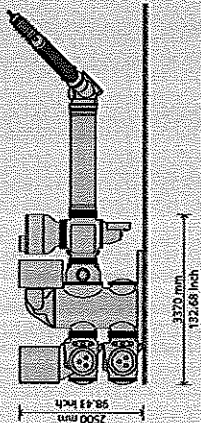

Direct connection to the transformer

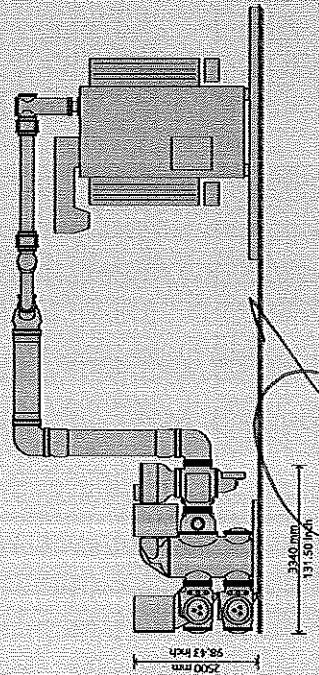

Typical configuration with double busbar

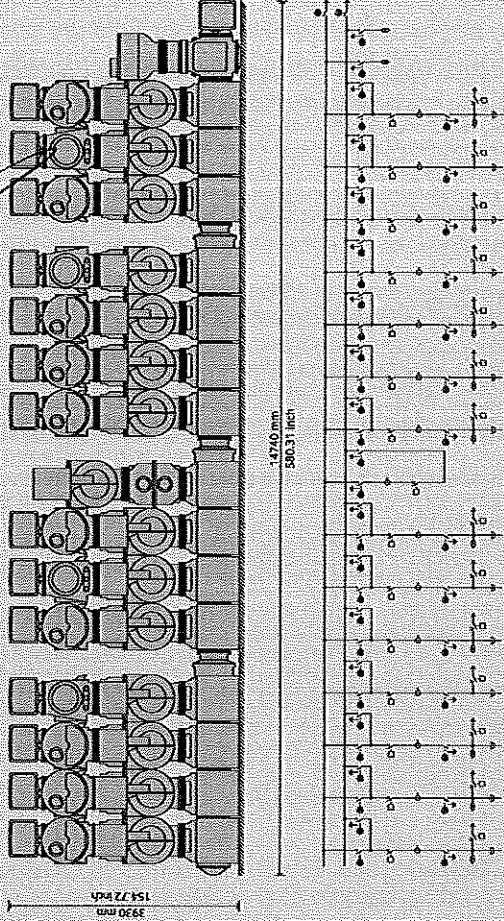

Ring busbar

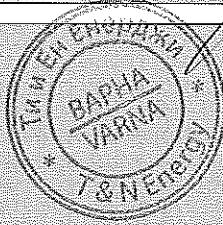
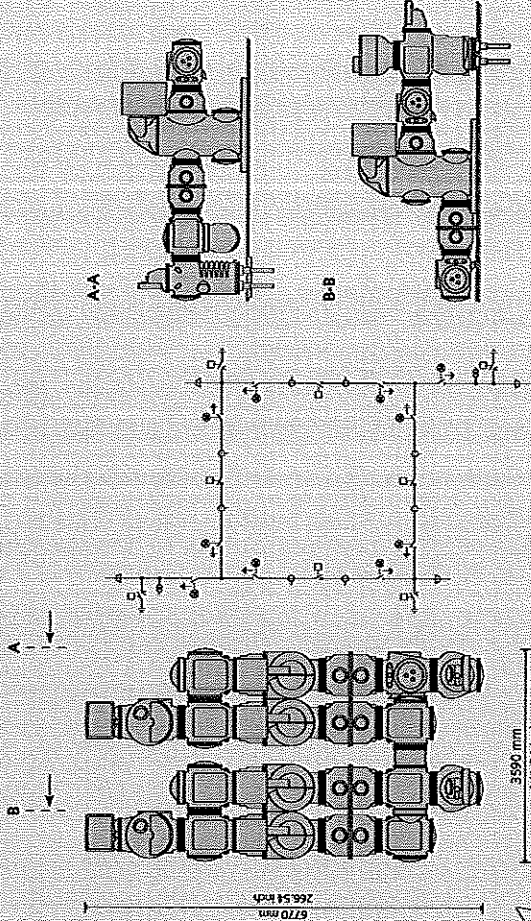

ВЪРНО С
ОРИГИНАЛА

16 Variations are possible with switchgear type series 72.5 KV

16 Siemens AG, Energy Sector, gas-insulated switchgear type series 82N8

16 Variations are possible with switchgear type series EDNE

16 Variations are possible with switchgear type series 72.5 KV

Technical data

Switchgear series		BDN8
Rated voltage		72.5/145 kV
Rated frequency		50/60 Hz
Rated power frequency withstand voltage (1 min)		140/275 kV
Rated lightning impulse withstand voltage (1.2/50 µs)		325/650 kV
Rated normal current		2500/3150 A
Rated short-circuit current		2500/3150 A
Rated peak withstand current		31.5/40 kA
Rated short-time withstand current		85/108 kA
Rated short-time withstand current		31.5/40 kA
Leakage rate per year and gas compartment		≤ 0.5% routine test ≤ 0.1% type test
Bay width		650/800/1200 mm
Height, depth		25.59/31.50/47.24 inches
Circuit-breaker operating mechanism (single-pole or common drive)		see typical bay arrangements
Rated operating sequence		store-energy spring O-0-3 S-CO-3 min-CO
Rated supply voltage		48-250 V DC
Expected lifetime		> 50 years
Ambient temperature range		-30°C to +40°C
Standards		IEC/IEEE

For further information

Name/Company _____
 Street _____
 Postal code/City/Country _____
 Phone/Fax _____
 E-mail _____

Phone: +49 9131 7-3 34 88
 Fax: +49 9131 7-3 44 96
 E-mail: h-gis.prd@siemens.com
 www.siemens.com/energy/hv-substations

Please send me information on the following topics:

- Gas-insulated switchgear product range
- Gas-insulated switchgear up to 245 kV
- Gas-insulated switchgear up to 300 kV
- Gas-insulated switchgear up to 550 kV
- HIS - Highly Integrated Switchgear up to 145 kV
- HIS - Highly Integrated Switchgear up to 550 kV
- container-type switchgear
- rent a GIS - temporary leasing of switchgear
- Gas-insulated transmission lines (GIL) the superior solution for special requirements
- further copies of this brochure

Typical configuration with 4-configuration

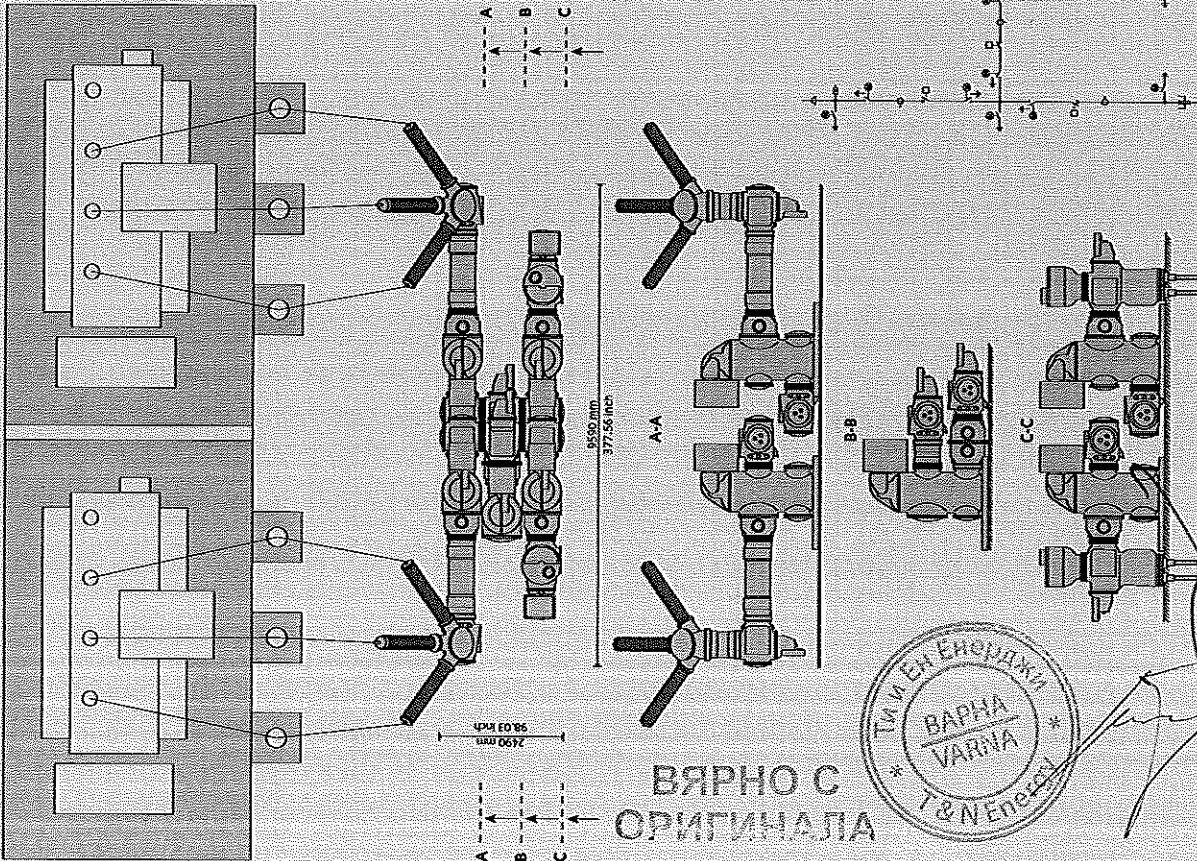

ВЯРНО С
ОРИГИНАЛА



[Handwritten mark]

[Handwritten mark]

Published by and Copyright © 2010:
Siemens AG
Energy Sector
Freytagstrasse 1
91058 Erlangen, Germany

Siemens AG
Energy Sector
Power Transmission Division
High Voltage Substations
Freytagstrasse 1
91058 Erlangen, Germany
www.siemens.com/energy/hv-substations

Order No. E50001-6620-A122X-4A00
Printed in Germany
Dlpp: 30000, 64bs No. 746D
fb3051 470733 W5 08 10
Printed on elementary chlorine-free
bleached paper.

All rights reserved.
Trademarks mentioned in this document
are the property of Siemens AG, its affiliates,
or their respective owners.

Subject to change without prior notice.
The information in this document contains
preliminary descriptions of the technical options
available, which may not apply in all cases.
The required technical options should therefore
be specified in the contract.

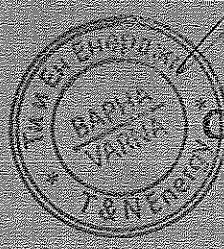

ВЯРНО С
ОРИГИНАЛА

[Handwritten signature]

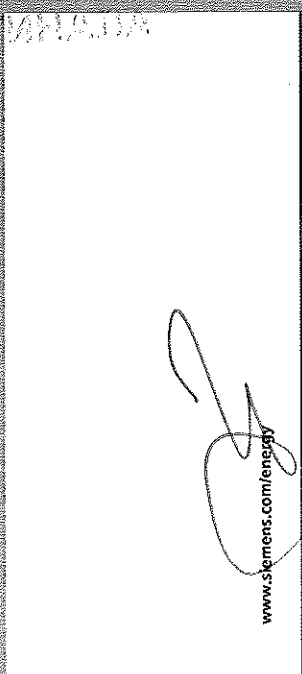

[Handwritten signature]

www.siemens.com/energy

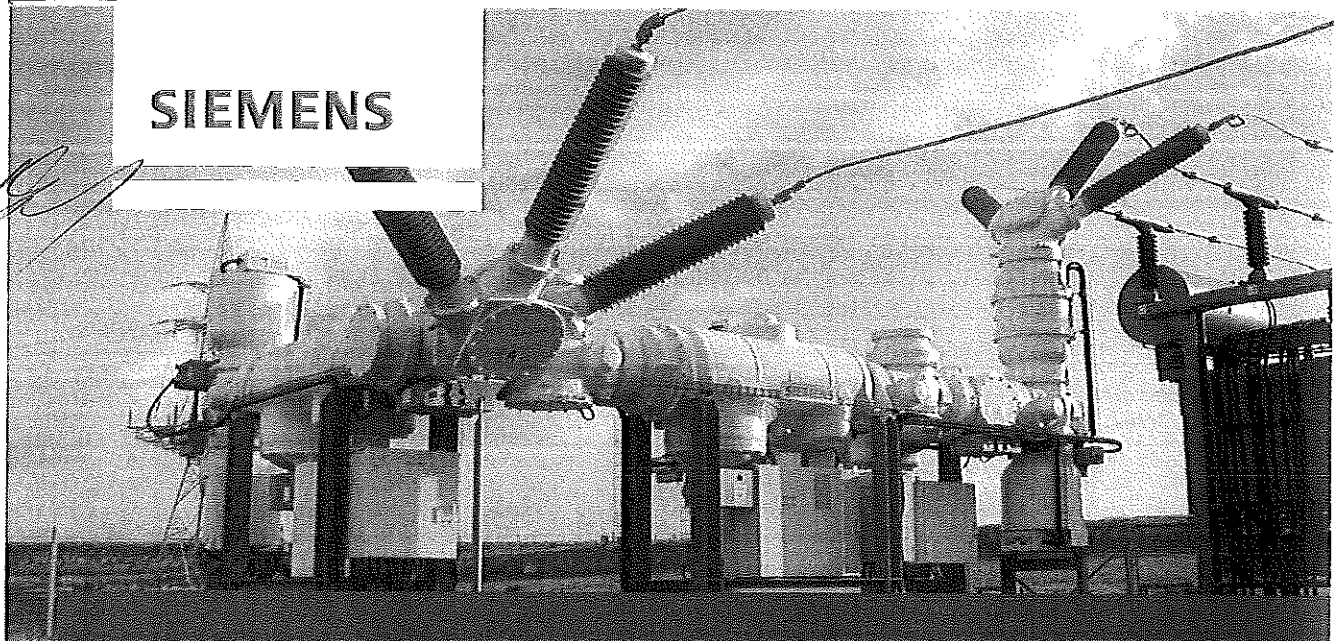
SIEMENS

Защита от корозия на газово изолирана КРУ



Изискванията спрямо контрола върху корозията за електроцентралите с газово изолирани КРУ се различават в зависимост от местата, на които се намират, и конкретните им околни среди. Действителните атмосферни условия на околната среда на строителната площадка на електроцентралата с газово изолирани КРУ и в изолирани спрямо влиянието на околната среда вътрешни помещения, където също така играе роля и относителната влажност, определят изискванията спрямо контрола върху корозията. Операторът е длъжен да се съобразява с тях.

Действителните атмосферни условия на околната среда могат да бъдат определени съгласно:

ISO 9223 или ISO 12944-2 като категория на корозионност или

IEC 60721-3-3 / IEC 60721-3-4 класифицирани като класове на атмосферни и климатични условия на околната среда или

Клас на Сименс за защита срещу корозия (вж. обяснението и таблицата).

Класове на Сименс за защита срещу корозия Четири класове на Сименс за защита срещу корозия "Нормален в закрити помещения", "Нормален в атмосферни условия", "Специален в закрити помещения" и "Специален в атмосферни условия" се базират на работните условия, описани в IEC 62271-1.

Тези четири класове на защита срещу корозия се различават основно между нормалните и

специалните работни условия и между монтажа в закрити помещения и този на открито.

Тези четири класове на защита срещу корозия се различават основно между нормалните и специалните работни условия и между монтажа в закрити помещения и този на открито. Праговите стойности на конкретните класове на защита на Сименс са дефинирани в таблица съгласно дадените класове и категории на текущите валидни международни норми.

Сименс АГ препоръчва дефинирането на действителните атмосферни условия на околната среда като категория на корозия съгласно ISO 9223, защото само тогава се отчитат всички съответни влияния по отношение на атмосферната корозия.

Дефиниция на категориите на корозия съгласно ISO 9223

Дефиницията на категорията на корозия съгласно ISO 9223 на базата на загуби от корозия (загуби на тегло) за метални образци от външни доставчици след една година е понастоящем най-лесният и най-устойчив спрямо грешки метод за определяне на атмосферната корозия. Нивото на несигурност е $\pm 5\%$.

ВЯРНО С
ОРИГИНАЛ

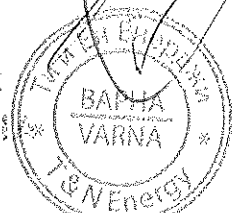

siemens.com/energy/hv-gis/

IEC 62271-1	Normal operating conditions		Special operating conditions	
	Interior area	Outdoor installation	Interior area	Outdoor installation
Siemens corrosion protection class	Indoor Normal	Outdoor Normal	Indoor Special	Outdoor Special
IEC 60721-3-3	3C1R, 3C1L, 3C1	-	3C2, 3C3, 3C4	-
IEC 60721-3-4	-	4C1, 4C2	-	4C3, 4C4
ISO 12944-2	C1, C2	C1, C2, C3	C3, C4, C5-M, C5-I	C4, C5-M, C5-I
ISO 9223	C1, C2	C1, C2, C3	C3, C4, C5, CX	C4, C5, CX
Rel. humidity	average $\leq 95\%$ at 24h and $\leq 90\%$ at 1 month	$\leq 100\%$	$\leq 100\%$	$\leq 100\%$

Remark: From the specification of a degree of pollution to IEC 60815-1 (Selection of isolators in high voltage grids in consideration of pollution) the actual corrosion loads are only partly derivable.

Не се препоръчва оценяването на категорията на корозия (нормативна или информативна), тъй като нивото на несигурност е много високо (-50% до +100% за разлика от $\pm 5\%$ по дефиниция).

Неясно описание на местоположението, от рода на "градска зона" или "мажки градове" не дават никаква информация относно действителния товар и не са подходящи за дефинирането на категорията на корозия.

Категоризация на слитието на околната среда съгласно IEC 60721

Друг метод за категоризация на действителните атмосферни условия на околната среда се базира на праговите стойности на емисиите на химически вещества (морски емисии, промишлени емисии) в атмосферата.

Тези прагови стойности на емисиите на химически вещества са дефинирани в IEC 60721-3-3 (вътрешна зона) и IEC 60721-3-4 (външна зона) като „химически активни вещества“ при условията на околната среда.

Защита от корозия

На базата на информацията, дадена на оператора относно действителните атмосферни влияния на околната среда, електроцентралите с газово изолирани КРУ са оборудвани със защита от корозия. В случай на липсващи данни, нормалните експлоатационни условия ще се приемат съгласно IEC 62271-1 и ще бъде установена една стандартна защита от корозия. Защитата срещу корозия, използвана от Сименс, се базира на една специална комбинация от система с покрития, метални покрития (напр., цинковани) и използването на устойчиви срещу корозия материали. Тази защита от корозия представлява резултат от многогодишен световен опит и конкретната комбинация от действащи фактори осигурява едно перфектно решение за защитата срещу корозия за електроцентралите с газово изолирани КРУ. Поради високата сложност на функционално ориентираната защита срещу корозия не е възможно да се демонстрира цялостната система на защитата срещу корозия само с едно просто отбелязване на дебелините на слоевете.

Системите с покритие, съвместими със стандарта ISO 12944-5, са предназначени да издържат до 15 години при най-висока атмосферна агресивност, съгласно конкретния клас на защита на Сименс.

При по-ниски нива на атмосферна агресивност експлоатационният срок на защитата се увеличава.

КРУ - системи с покрития за газово изолирани КРУ
Електроцентралите на Siemens с газово изолирани КРУ се произвеждат почти изцяло от устойчиви на корозия материали съгласно изискванията на DIN EN ISO 8044. Матрият на брой части, изработени от некорозионноустойчиви материали от черни метали, преминават технологична обработка с нанасяне на покритие съгласно изискванията на ISO 12944 1).

Техническите предпазни мерки, от рода на нанасяне на противокондензнатна защита, допълнително понижават нивото на корозия.

Типът и изпълнението на системата с покритие съгласно спецификацията на Сименс зависят от мястото на строежа на електроцентралата с газово изолирани КРУ, което означава действителното въздействие върху покритието посредством атмосферните условия, техническата функция, срока на защита и материала на основата. Съгласно спецификациите на Сименс за даден компонент са възможни различни материали и производствени операции. Тъй като електроцентралите с газово изолирани КРУ се изграждат от няколко различни секции, изработени от различни материали, не съществува една единствена система с покритие за електроцентрала с газово изолирани КРУ.

1) За категориите корозия до C3, са достатъчни рани от поцинкована стомана.

Siemens AG
Energievertriebs
Freyeslebenstraße 1
91058 Erlangen, Германия

Siemens AG
Отдел „Енергии високо напрежение“
Газово изолирани КРУ
EM HP GS MB QV P1
Nottendammallee 104
13629 Берлин, Германия

5 06 2015 1, Siemens AG

ВАРНО С
ОРИГИНАЛА



siemens.com/energy/hv-gis/

To whom it may concern

Name: Andreas Karg
 Department: E T HP GS DE MF TS 3
 Telephone: +49 30 386-25336
 Fax: +49 30 386-26301
 E-Mail: andreas.karg@siemens.com

Our Reference: E T HP GS DE MF TS 3/Q/0114Ka
 Date: 2012-10-09

Siemens GIS-Switchgear Type 8DN8 Reliability & Availability

The mean time between failures (MTBF) based on major faults of Siemens GIS, type 8DN8 (72 kV up to 170 kV) application amounts to > 1,600 bay years (Effective: 2012-10-09). This is equivalent to a failure rate of $\lambda < 0.06$ failures/100 years per GIS bay.

According to "Cigré WG 23/02, 02/2000, Major Failures of GIS 1967-1995" a MTBF > 70 bay years and a failure rate of $\lambda < 1.45$ failures/100 bay years are recommended for GIS up to 200 kV.

More than 59,150 bay years of 8DN8 are world wide in service without any major technical irregularities, which might lead to the end of life of the GIS equipment.

The total time to solve the problems at site was depending on the kind of failure and took a time starting from one day up to several days. A fast reaction could be reached because of the availability of spare parts by taking them out of the actual production.

General Data of 8DN8

Frequency for Routine Mtc.	Duration for Routine Mtc.	Frequency for Major Mtc.	Duration for Major Mtc.	Mean Time to Repair	Expected Life Time of Equipment
9* years <small>*1st visual inspection</small>	1 day/bay	25 years	3 days/bay	1 - 9 days	> 50 years

Operational availability of 8DN8 (considered per bay)

	Planned Mtc. for the expected Life Time Out of service	Unplanned Mtc.			Availability
		MTBF	MTTR	Out of service	
8DN8	1.44 h/year	1,600 years	5 days	0.09 h/year	99.98%

The product 8DN8 has a well reliability and availability, especially in comparison to figures published by Cigré. To increase the well reliability and availability, the processes for assembling at site and at the factory were modified in the past as a reaction of recognized causes of events.

Andreas Karg

Quality Manager
 Siemens AG, High Voltage Substations, Manufacturing Berlin

ВЪРНО СРИГУНАЛ
 Т&N ENERGY
 ВАРНА
 VARNNA

Confirmation

Report-No.: E T H S M F B 11 – 3018

Content: 1 Sheet

Object: GIL and GIS manufactured by Siemens, gas tightness of < 0.5 %

Applied Standard: IEC 62271-1, -203, -100, -102, IEC 61640

Manufacturer: Siemens AG, E T H S M F

The tightness of the single GIL and GIS – modules is characterized by the tightness of the enclosure, the design and quality of the sealing systems between flanges, covers and sealing systems of shafts. For preparation of type test objects the modules are passing the standard manufacturing process as later all modules of the production, too. The type tests demonstrate that the design, the different materials and the manufacturing processes are alright and technical requirements are fulfilled. The tightness of the enclosure and the sealing design is type tested successfully by integral measurements under laboratory conditions according to the above mentioned international standard.

Siemens confirms that the test results demonstrate that the leakage rate of single modules is below 0.1 % under this type test conditions.

For the manufacturing process and also for the on site control the special laboratory conditions are not practicable. The routine test and on site test equipment are able to perform tightness tests up to a level of < 0.5 % leakage rate as it is also required in the above mentioned international standard. Nevertheless the very well service experience with GIS technology since more than 40 years of our customers confirms a very high quality of the SF6 tightness in service and a much lower leakage rate than 0.5 %.

Jander
Siemens AG
E T H S M F B 1
GIS-Factory
Product Technology and Quality
13029 Berlin
E T H S M F B 11
Siemens Schaltwerk Berlin

БАРНА
ВАРНА
ENERGY
БАРНО С
ПРОИЗВОДИТЕЛ

Berlin, September 13th, 2011

Сименс АГ, Е Т Н, 13623 Берлин

Име
Отдел

Норман Аал
E T HP GS DE MF QM PT

Телефон
Факс
Имейл
Интернет

+49 (173) 7074591
+49 (30) 386-24188
norman.ahl@siemens.com
www.siemens.com

до всички заинтересовани

Ваше писмо от
Наша референция
Дата

E T HP GS DE MF QM PT/M/3680
10 март 2014

Газово изолирани КРУ за монтаж на закрито – системи за покритие

Въведение

Газоизолираните КРУ за монтаж на закрито от Сименс са произведени почти изцяло от корозионно-устойчиви материали съгласно DIN EN ISO 8044. Малкото компоненти от неустойчиви на корозия феритни материали имат покритие (най-често галванизирани). Затова, газоизолираните КРУ за монтаж на закрито от Сименс при експлоатация в нормални условия имат нужда от лаково защитно покритие против корозия само върху негалванизирани компоненти от неустойчиви на корозия феритни материали. Обаче, по технически причини понякога беше нужно да се покрият и други материали.

Техническите мерки, като нагревател срещу кондензация на вода, допълнително намаляват корозията. Системите за покритие на Сименс Е Т НР GS бяха одобрени при вътрешни лабораторни изпитания, напр. при изпитания в солена мъгла съгласно DIN EN ISO 9227. Типът и структурата на различните системи за покритие на Сименс Е Т НР GS зависят до голяма степен от локалните условия на средата на мястото за монтажа, атмосферните въздействия върху покритието, техническите функции, срокът за трайност на защитата и базовия материал. Също така са възможни няколко алтернативни материали и производствени процеси съгласно вътрешни спецификации на Сименс Е Т НР GS. Поради фактът, че газоизолираните КРУ от Сименс се състоят от множество различни компоненти, които се изработват от различни материали, единна система за покритие на газоизолираните КРУ е неприложима.

Затова, по-долу следва описание само на общите подробности за производствените процеси и изискванията.

**ВАРНО С
ОРИГИНАЛА**



Сименс АГ
Сектор Енергетика; Ръководител:
Михаел Зюс

Нонендамалее 104
13629 Берлин
Германия

Тел.: +49 (30) 386-0

Siemens Aktiengesellschaft: Chairman of the Supervisory Board: Gerhard Cromme;
Managing Board: Joe Kaeser, Chairman, President and Chief Executive Officer;
Roland Busch, Klaus Helmrich, Hermann Requardt, Siegfried Russwurm, Michael Suess, Ralf P. Thomas
Registered offices: Berlin and Munich, Germany; Commercial registries: Berlin Charlottenburg, HRB 12300, Munich, HRB 6684
WEEE-Reg.-Nr. DE 23691322

Общи изисквания за покритията

Лакови материали Само специфицирани от Сименс E T HP GS материали ще се използват, вземайки предвид инструкциите за работа от производителя.

Изпълнение Лаковите покрития трябва да се прилагат равномерно, като не трябва да се появяват издутини, сълзене, петна или ивици.

Дебелина на покритието Специфицираните дебелини на покритието са минималните. Допустимата максимална дебелина на покритието е двойната минимална дебелина. По-голяма дебелина на покритието е допустима, само ако няма неблагоприятен ефект върху функционирането на частите.

Сила на прилепване Изпитания с решетка съгласно ISO 2409, параметърът на решетката може да бъде 0 или 1.

Лаково антикорозионно покритие на железни материали

Технологични процеси - цинк фосфатизиране (покритие от преобразуван фосфат EN12476 -Fe/Znph)
- грундиране
- прахово лакиране
или
- премахване на ръждата и отлаганията, където е необходимо
- почистване/разгресиране
- фосфатизиране (покритие от преобразуван фосфат EN12476 - Fe/Znph или Fe/Feph)
или
- почистване/разгресиране
- продухване
и
- лакиране с SWH покритие

Лаково покритие на галванизирани железни материали

Не е необходимо за защита от корозия, а само по технически причини.

Технологични процеси - горещо галванизирание
- цинк фосфатизиране
- грундиране
или
- горещо галванизирание
- грубо изтъркване или измитане
- грундиране
или
- почистване/разгресиране
- продухване
- прахово галванизирание
или
- почистване/разгресиране
- продухване
- покритие с SWH цинкова прахова боя
или
- галванизирание
и
- лакиране с SWH покритие

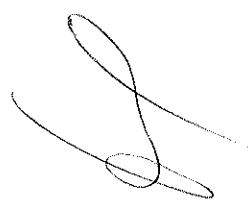
ВЕРНО С
ОРИГИНАЛА

Лаково покритие на алуминиеви материали

Не е необходимо за защита от корозия, а само по технически причини.

- Технологични процеси
- почистване/разгресиране
 - продухване (само съдовете)
- или
- хромирано покритие съгласно DIN 50939
 - разгресиране/измитане (вж. ISO 12944-4 раздел 6.2.3.4.1).
- и
- лакиране с SWH покритие

Лаково покритие на медни материали и неръждаема стомана

Не е необходимо за защита от корозия, а само по технически причини.

- Технологични процеси
- почистване/разгресиране
 - продухване (само съдовете)
 - лакиране с SWH покритие

Дебелина на покритието

Условията на средата, отговарящи на нормалните експлоатационни условия съгласно IEC 62271-1, изискват „нормален клас на защита за монтаж на закрито“. Съгласно тази спецификация на Сименс E T HP GS са необходими следните посочени минимални дебелини на покритието.

- Всички лакови защитни антикорозионни покрития на железни материали > 30µm
- Всички лакови покрития по технически причини (визуално покритие) ~ 30µm

Заклучителни забележки

- Газоизолираната КРУ за монтаж на закрито от Сименс е произведена почти изцяло от корозионно-устойчиви материали съгласно DIN EN ISO 8044.
- Компонентите от неустойчиви на корозия феритни материали са най-често галванизирани.
- Лакова антикорозионна защита на негалванизирани компоненти от неустойчиви на корозия феритни материали.
- Всички системи за покритие бяха одобрени при вътрешни лабораторни изпитания и се доказаха в десетилетия практика.
- Тази корозионна защита на корозионно-устойчиви материали и покрития подобрява експлоатационната и антикорозионната безопасност при използване в нормални експлоатационни условия съгласно IEC 62271-1.

Аал
E T HP GS DE MF QM PT
Завод за КРУ Берлин

Берлин, 10 март 2014

ВЯРНО С
ОРИГИНАЛА

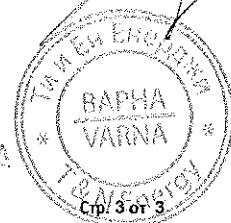

Siemens AG, E T H, 13623 Berlin

to whom it may concern

Name
Department

Norman Ahl
E T HP GS DE MF QM PT

Telephone
Fax
E-mail
Internet

+49 (173) 7074591
+49 (30) 386-24188
norman.ahl@siemens.com
www.siemens.com

Your letter of
Our reference
Date

E T HP GS DE MF QM PT/M/3680
10. March 2014

GIS indoor normal - coating systems

Introduction

Siemens indoor gas-insulated switchgears are manufactured almost completely with corrosion-resistant materials according to DIN EN ISO 8044. The few components of not corrosion-resistant ferrous materials are coated (mostly galvanized). Therefore need a Siemens indoor gas-insulated switchgear used under normal service conditions, only on non-galvanized components of not corrosion-resistant ferrous materials a varnish corrosion protection coat. However for technical reasons it was sometimes necessary to coating other materials.

Technical measures like condensation water heater additional reduce the corrodibility. Siemens E T HP GS coating systems were qualified in internal laboratory tests, e.g. with salt mist examinations according to DIN EN ISO 9227. Type and construction of the different Siemens E T HP GS coating systems are dependent largely upon on the local environmental conditions on the installation site, the stress of coating by the atmospheric influences, the technical function, term of protection and the base material.

Several alternative materials and production processes are also possible according to internal Siemens E T HP GS specifications. Due to the fact that Siemens gas-insulated switchgear comprehends of many different components which are manufactured from different materials, a uniform coating system for the gas-insulated switchgears is not applicable.

Therefore, only the general details of the production processes and requirements are described by specified base material in the following.

ВЯРНО С
ОРИГИНАЛА

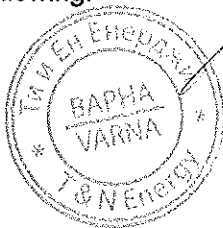

Siemens AG
Energy Sector, Head: Michael Suess

Nonnendammallee 104
13629 Berlin
Germany

Tel: +49 (30) 386-0

Siemens Aktiengesellschaft: Chairman of the Supervisory Board: Gerhard Cromme;
Managing Board: Joe Kaeser, Chairman, President and Chief Executive Officer;
Roland Busch, Klaus Helmrich, Hermann Requardt, Siegfried Russwurm, Michael Suess, Ralf P. Thomas
Registered offices: Berlin and Munich, Germany; Commercial registries: Berlin Charlottenburg, HRB 12300, Munich, HRB 6684
WEEE-Reg.-Nr. DE 23691322

General requirements of coatings

Varnish materials Only Siemens E T HP GS specified materials shall be used under consideration of the manufacturer's processing instructions.

Execution The varnish coats must be applied with even, visual coverage, they may not exhibit any blister, tears, stains or streaks.

Coating thickness The specified coating thicknesses are minimum coating thicknesses. The permissible maximum coating thickness is the double minimum coating thickness. Greater coating thickness is only acceptable if they have no adverse effect on the functioning of the parts.

Adhesion strength Grid test according to ISO 2409, the grid parameter may be 0 or 1.

Varnish corrosion protection coating of iron materials

Production processes - zinc phosphatise (Phosphate conversion coating EN12476 - Fe/Znph)
- prime
- powder varnish
or
- remove rust and scale where necessary
- clean/degrease
- phosphatise (Phosphate conversion coating EN12476 - Fe/Znph or Fe/Feph)
or
- clean/degrease
- blast
and
- varnish with SWH top coat

Varnish coating of galvanised iron materials

For corrosion protection not required, only for technical reasons.

Production processes - hot galvanise
- zinc phosphatise
- prime
or
- hot galvanise
- roughen or sweep
- prime
or
- clean/degrease
- blast
- spray galvanise
or
- clean/degrease
- blast
- coat with SWH zinc dust paint
or
- galvanise
and
- varnish with SWH top coat



Varnish coating of Aluminium materials

For corrosion protection not required, only for technical reasons.

- Production processes
- clean/degrease
 - blast (only vessels)
- or
- chromate coating acc. to DIN 50939
 - degreasing/sweeping (see ISO 12944-4 sect. 6.2.3.4.1).
- and
- varnish with SWH top coat

Varnish coating of copper materials and stainless steel

For corrosion protection not required, only for technical reasons.

- Production processes
- clean/degrease
 - blast (only vessels)
 - varnish with SWH top coat

Coating thickness

Environmental conditions corresponding to the normal service conditions according to IEC 62271-1 requires the „indoor normal protection class“. According to this Siemens E T HP GS specification the following listed minimum coating thicknesses are necessary.

- All varnish corrosion protection coatings on iron materials > 30µm
- All varnish coatings for technical reasons (coat visually covering) ~ 30µm

Final remark

- Siemens gas-insulated switchgear for indoor use is manufactured almost completely from corrosion-resistant materials according to DIN EN ISO 8044.
- Components of not corrosion-resistant ferrous materials are mostly galvanised.
- Varnish corrosion protection coating on non-galvanised components of not corrosion-resistant ferrous materials.
- All coating systems were qualified in internal laboratory tests and have proved themselves in decades of practice.
- This corrosion protection of corrosion-resistant materials and coatings increases the operational and corrosion safety by use under normal service conditions according to IEC 62271-1.

Ahl
E T HP GS DE MF QM PT
Siemens AG
Schaltwerk Berlin
GIS-Factory
Product Technology and Quality
13025 Berlin

Berlin, 10 March 2014

ВЯРНО
ОРИГИНАЛ

